

# Overview of SINAP Timing System

Electronics Group  
Beam Diagnostics & Control Division  
SINAP



中国科学院上海应用物理研究所  
Shanghai Institute of Applied Physics, Chinese Academy of Sciences

# Outline

- v1 timing system structure
- v1 hardware
- v1 performance
- v1 in PLS-II
- v2 timing system structure
- v2 hardware



# SINAP v1 timing system structure

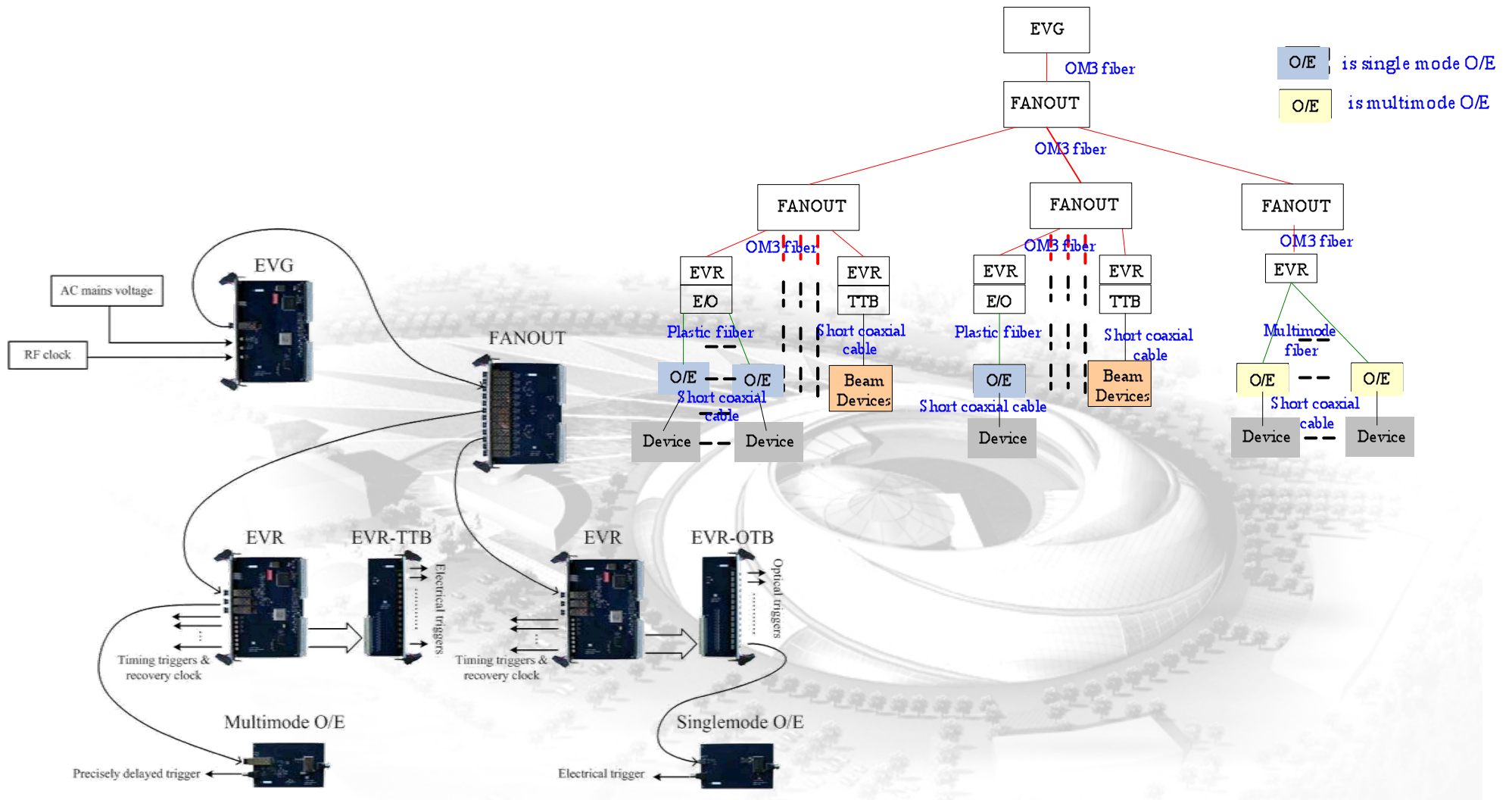

# Hardware List

- SINAP v1 timing system:

EVG

EVR

FANOUT

TTL VME Transition Board

Plastic fiber VME Transition Board

Multimode fiber O/E

Plastic fiber O/E



# EVG

VME 6U module; A16D32 addressing

Input: 1ch RF clock (0 – 10 dBm)

1ch AC line (3Vp-p typical)

Output: 1ch multi-mode fiber

1ch Sequence RAM trigger  
(TTL)

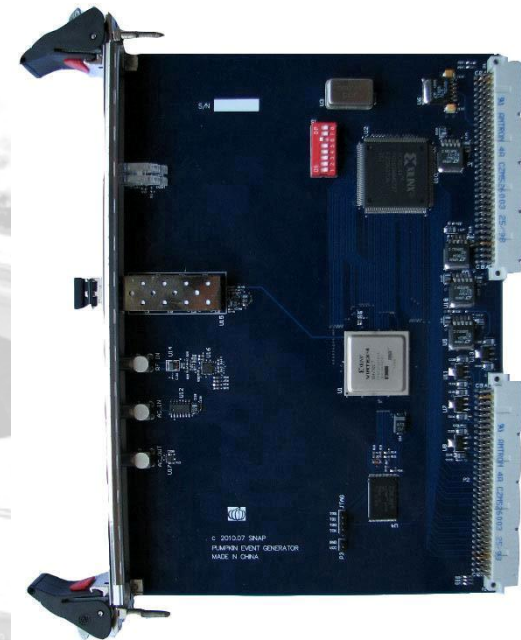

# EVR

VME 6U module; A16D32 addressing

Input: 1ch multi-mode fiber

1ch interlock input (TTL)

Output: 3ch TTL trigger/clock

3ch LVPECL trigger/clock

1ch CML RF recovery clock

2ch Multi-mode fiber trigger



# FANOUT

VME 6U module

Input : 1ch multimode fiber

Output: 12ch multimode fiber

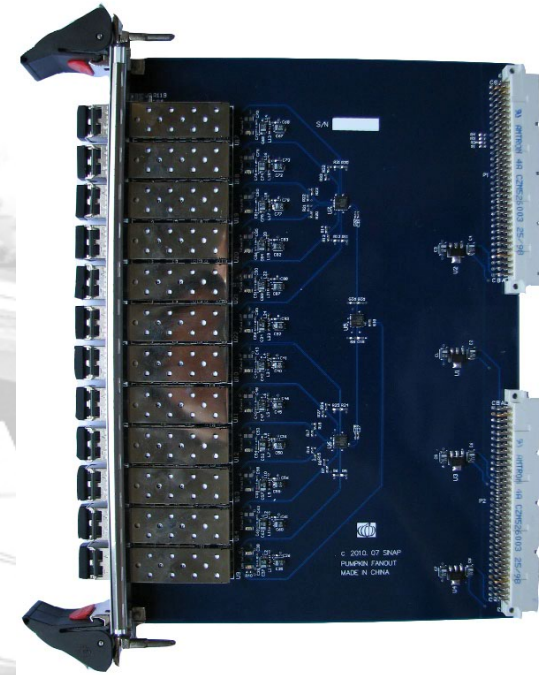

# TTL VME Transition Board

VME transition board

Output: 14ch TTL trigger





# Plastic Fiber VME Transition Board

VME transition board;  
Output: 14ch optic trigger  
(Agilent HFBR-1528)



# Multi-mode Fiber O/E

Standalone module

Input: 1ch multi-mode fiber

1ch power supply (24V/1A)

Output: 1ch TTL (50ohm)



# Plastic Fiber O/E

Standalone module

Input: 1ch multi-mode fiber

1ch power supply (24V/1A)

Output: 1ch TTL

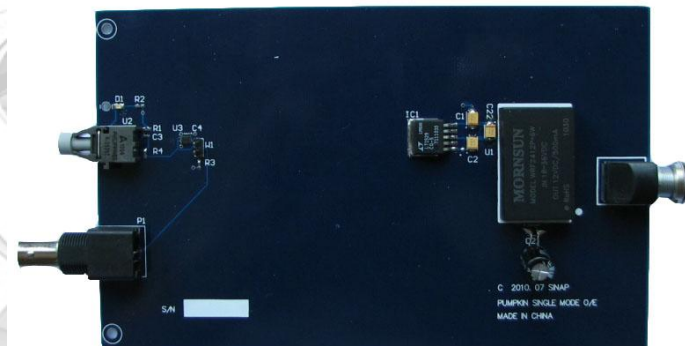

# Performance Testing

- Stability

coding-decoding error

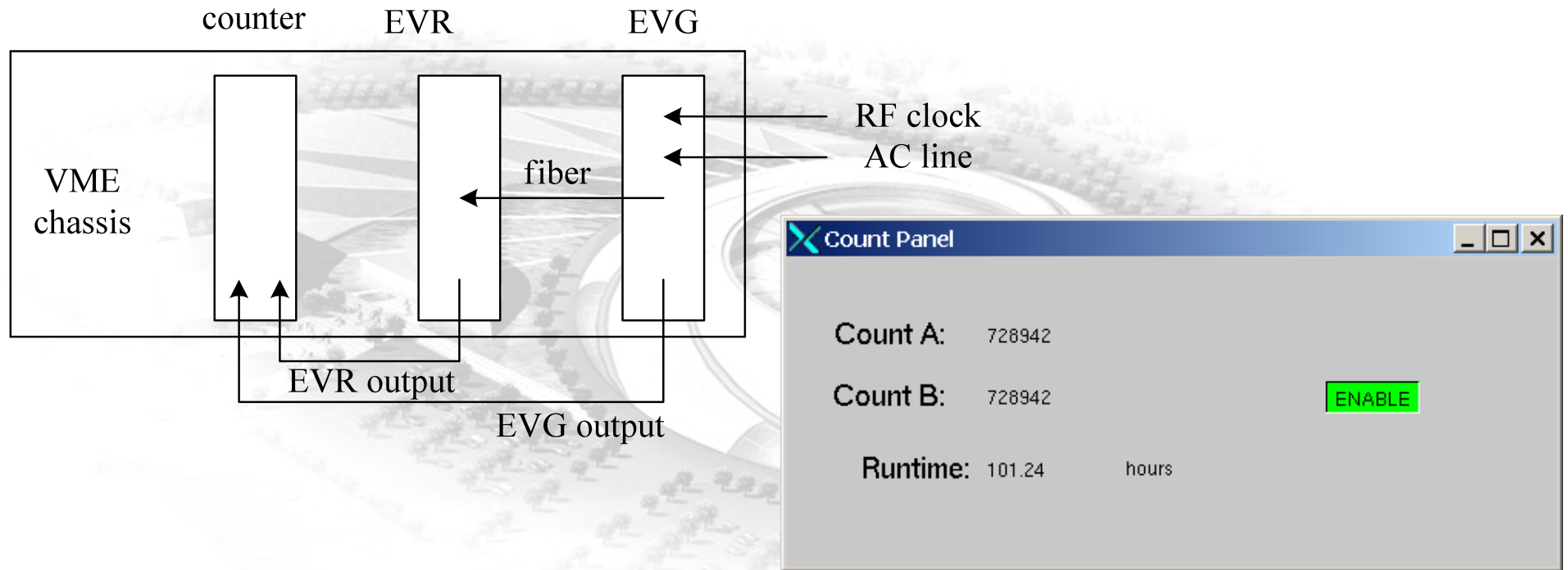

# Performance Testing

- Jitter
- EVR TTL output  
< 6ps



# Performance Testing

- Jitter

Multi-mode O/E output  
< 10ps

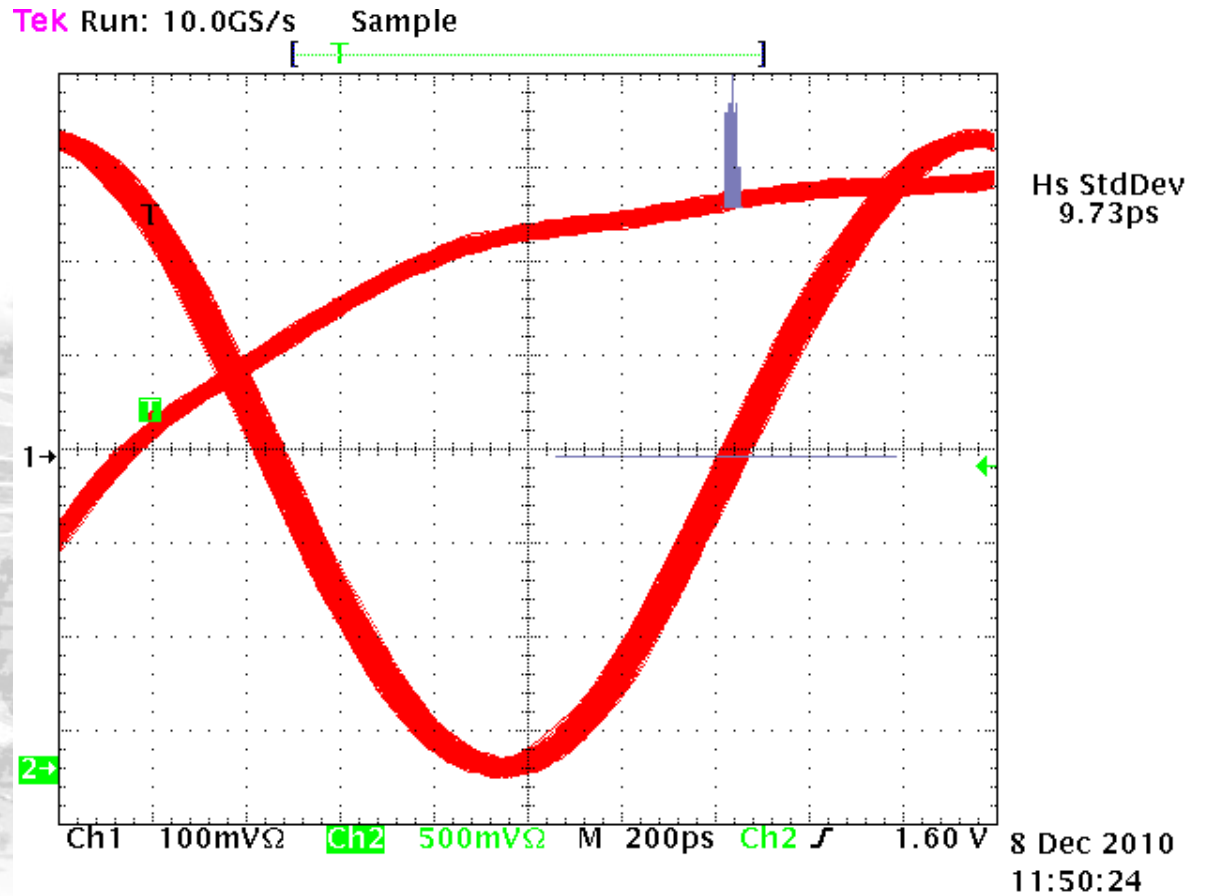

# MRF Jitter Performance

- EVR TTL output > 18ps

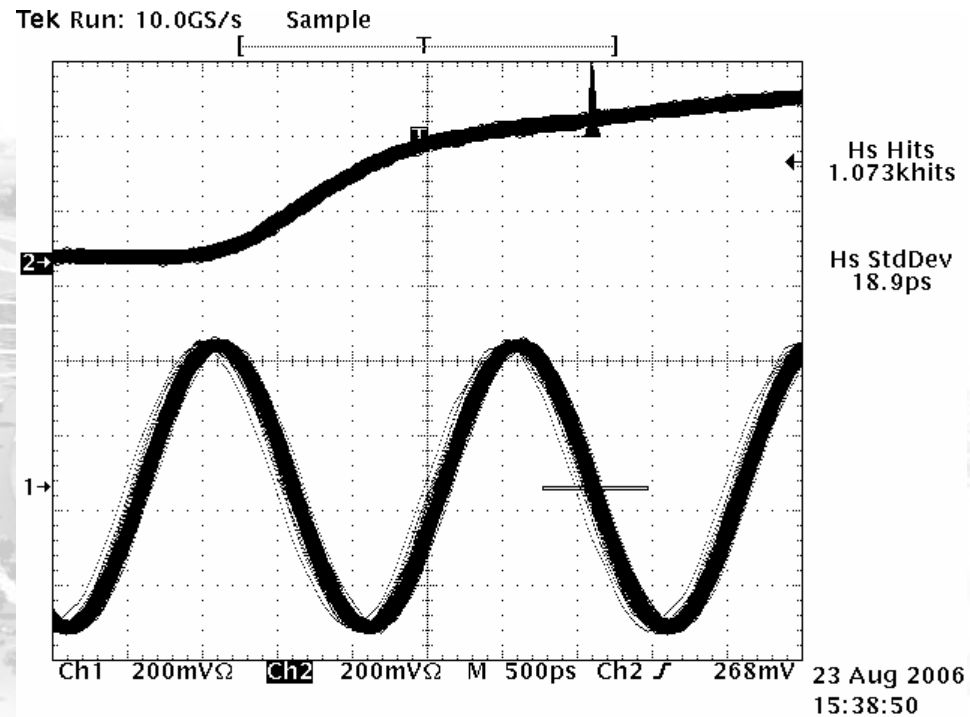

# Performance Testing

- Phase Shift

Phase shift with temperature changing (35ps/°C)

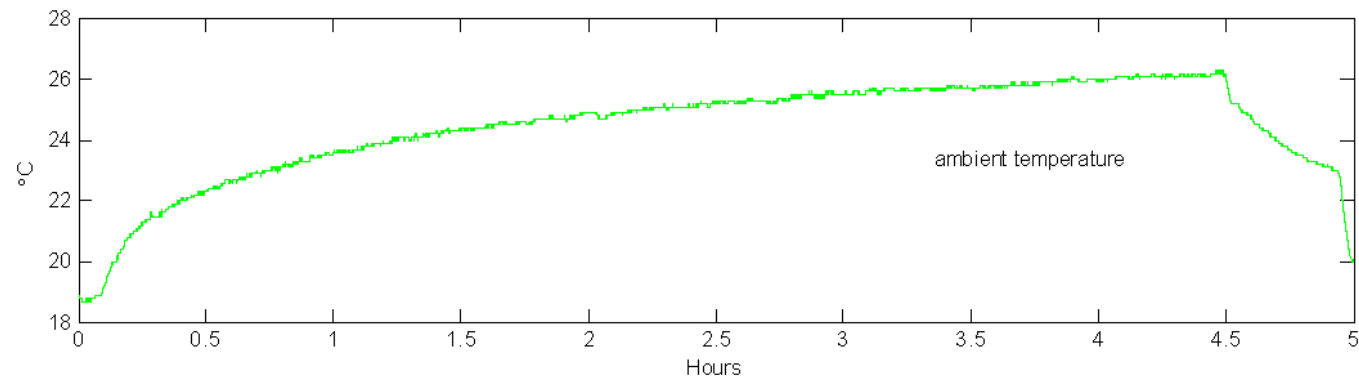
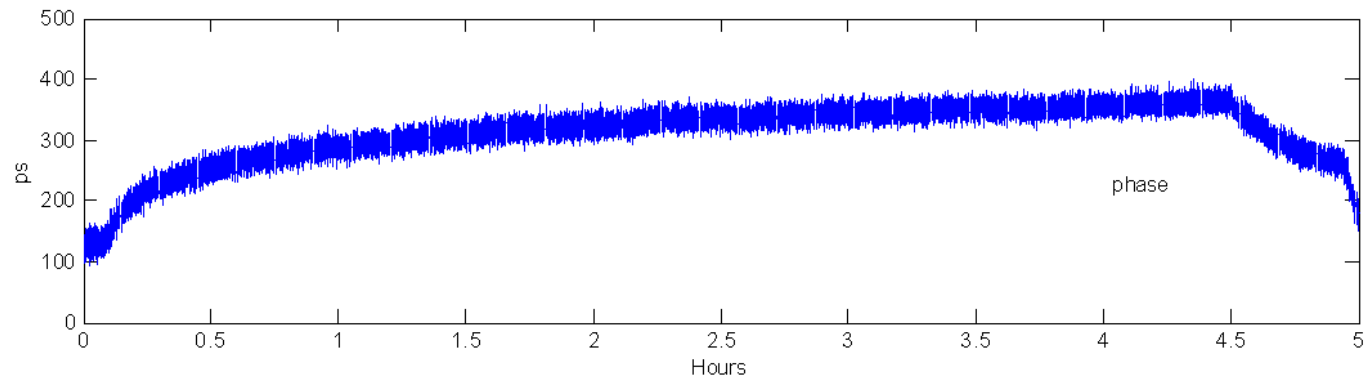



# v1 in PLS-II

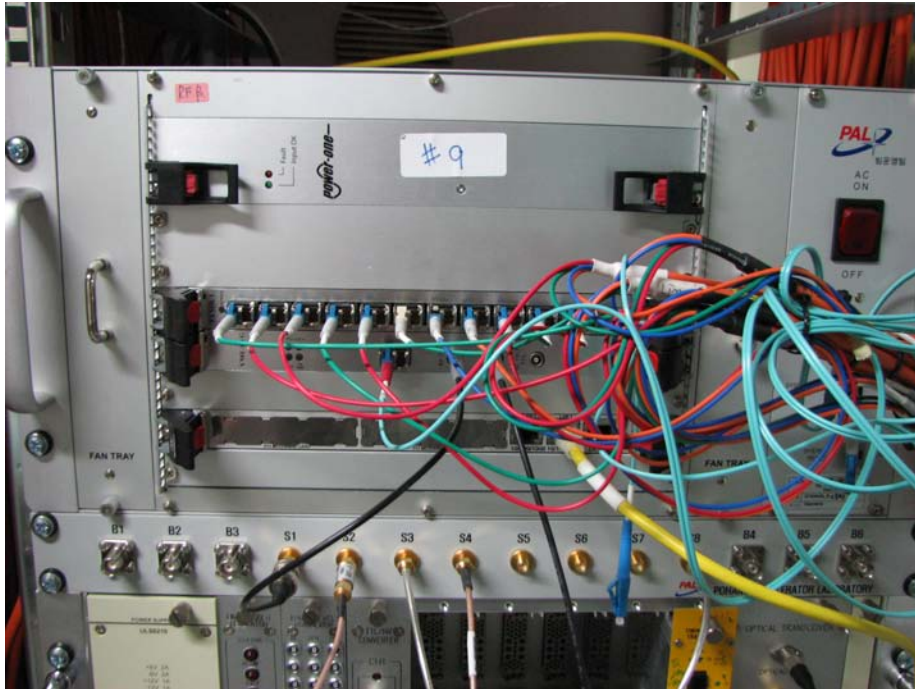

in RF station (EVG)

in LINAC control room

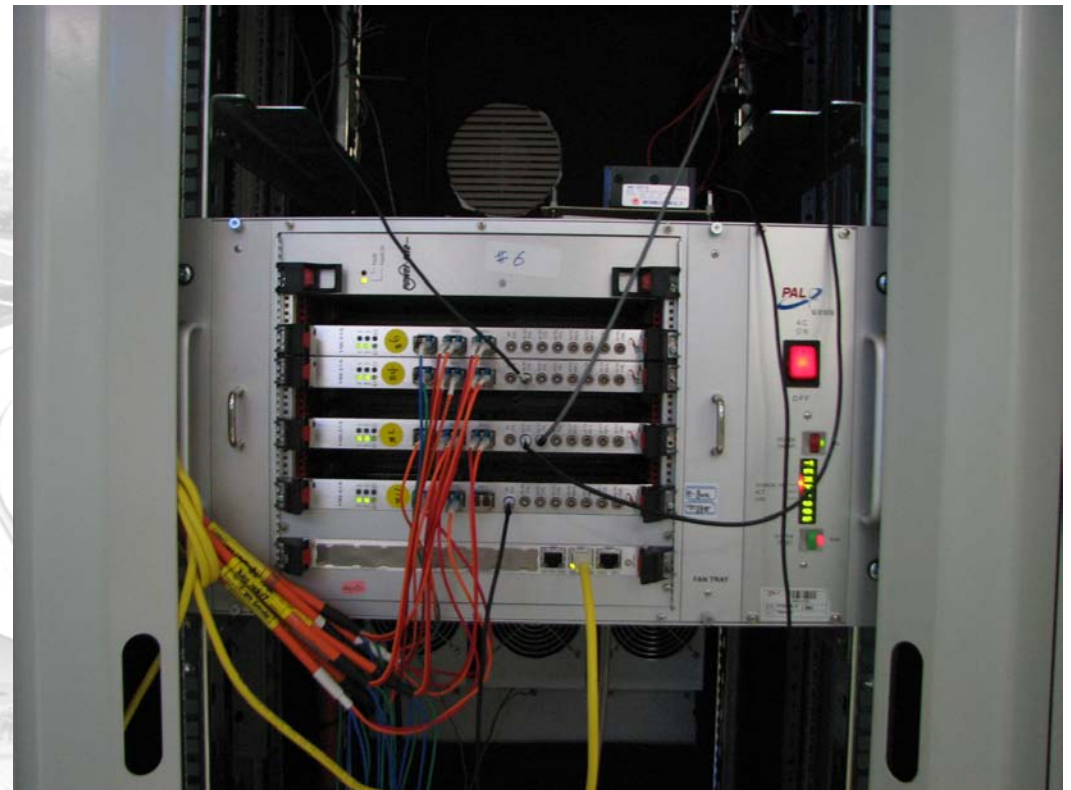

# v1 in PLS-II



in E-gun

in Klystron & Modulator



# V1 in PLS-II

in Storage Ring

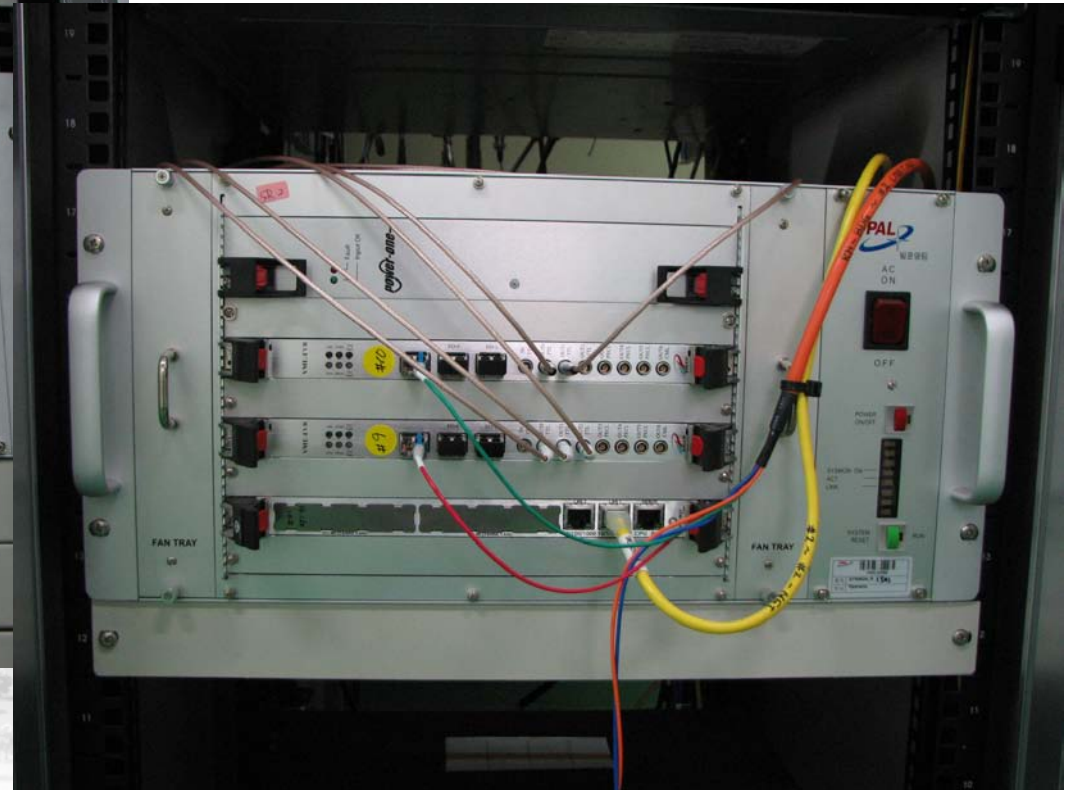

in Kicker station

# SINAP v2 timing system structure

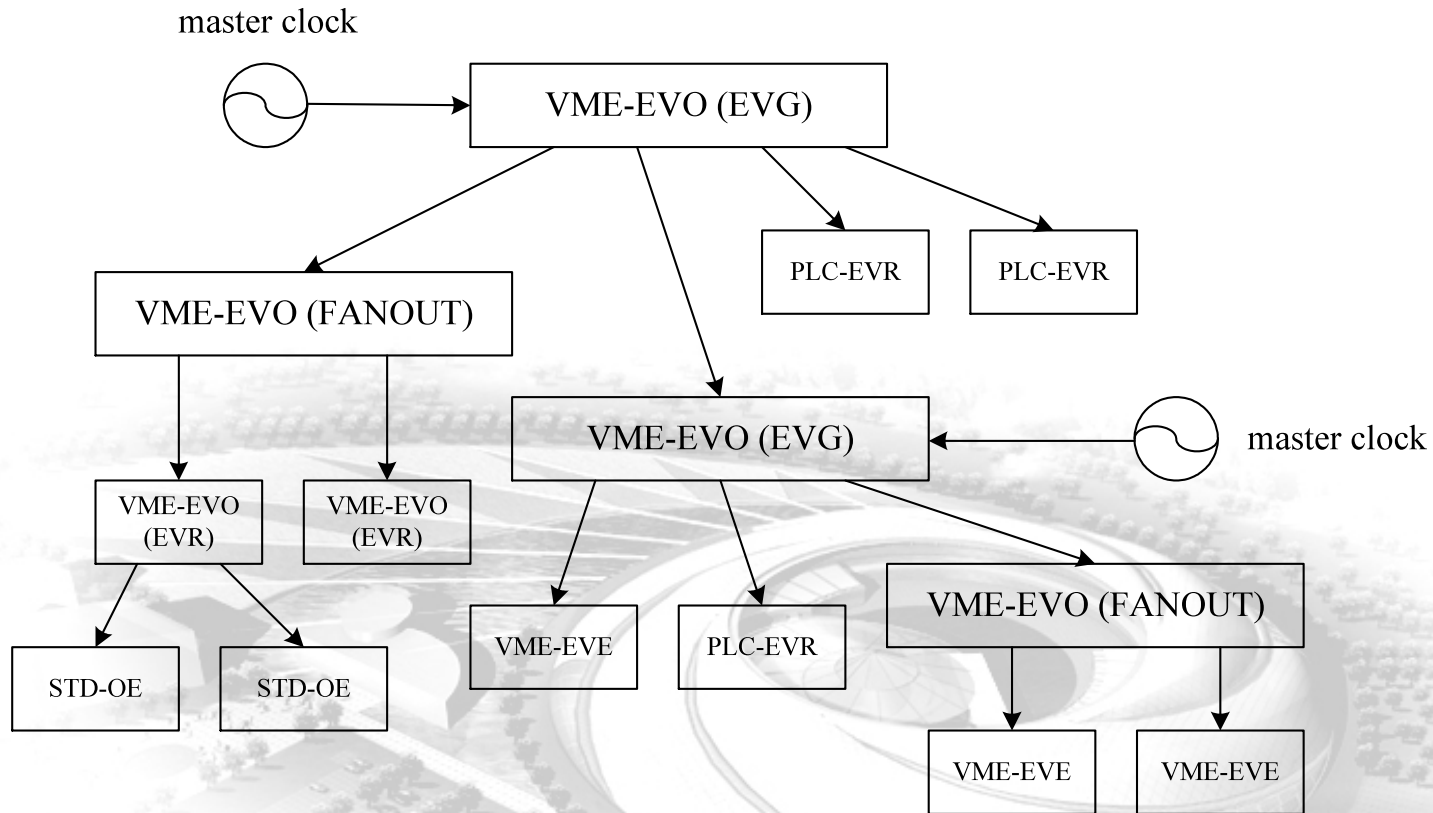

# System Design

- Synchronization

## Broadcasting mode

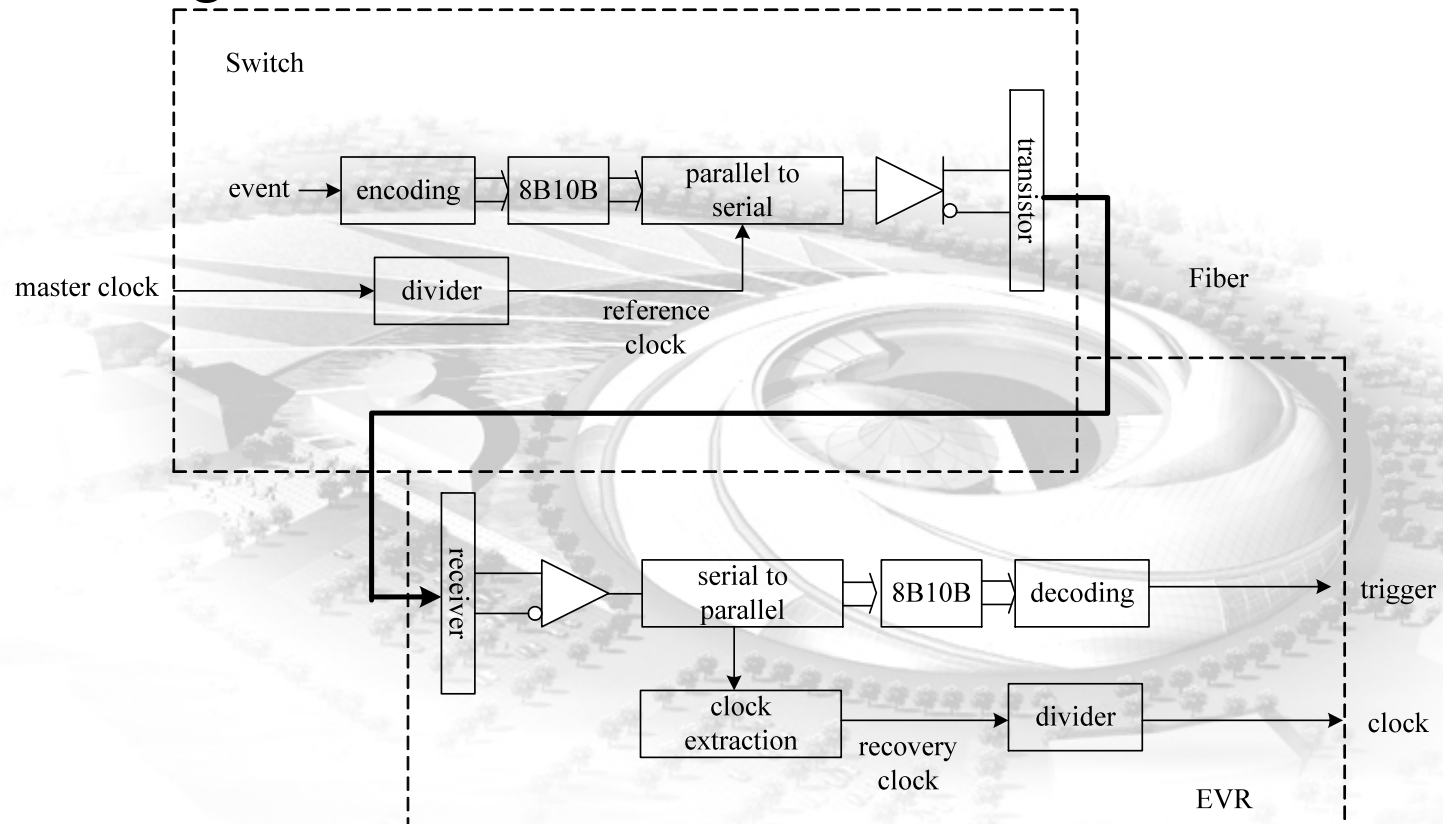

# System Design

- Deterministic Data Transfer
- Switching mode

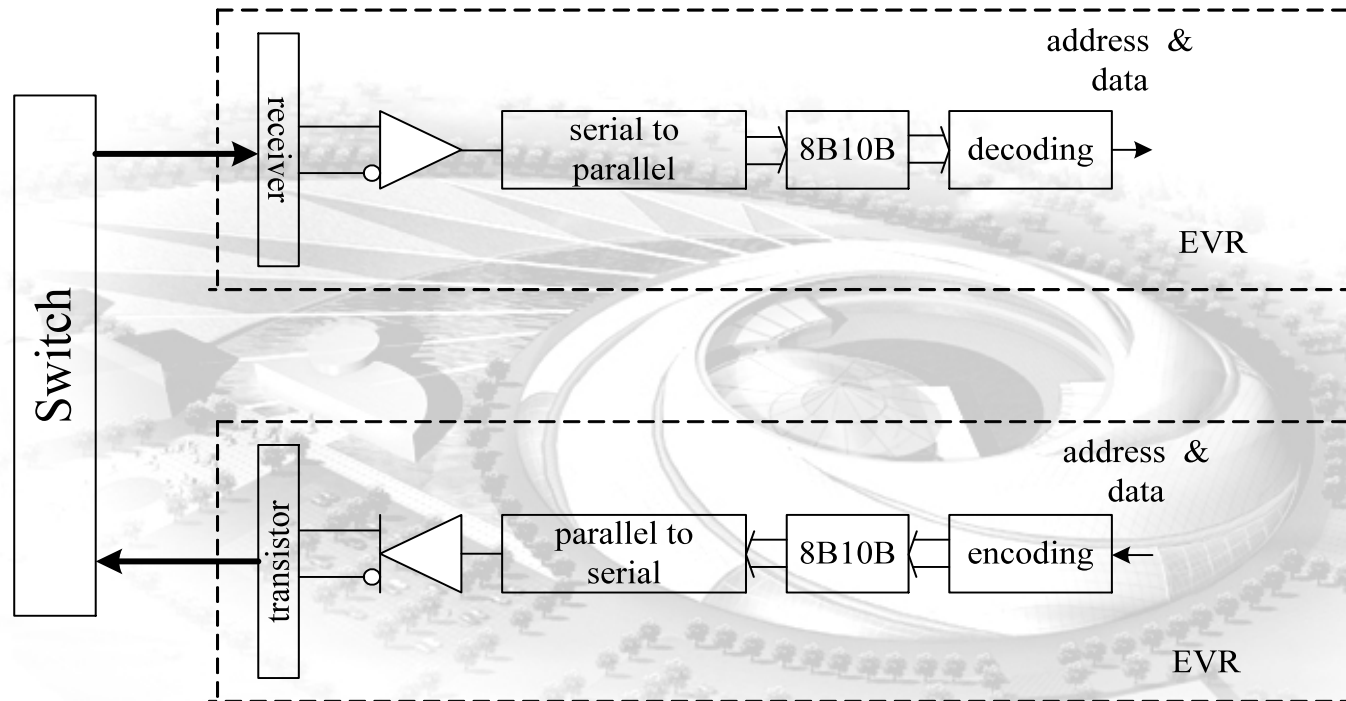

# System Design

- Frame Format

1 byte for trigger code

1 byte for data frame

1 byte	1 byte
trigger	data frame
K28.5	data frame
K28.5	data frame
K28.5	data frame
trigger	data frame
K28.5	data frame

⋮ ⋮

The minimum interval of trigger is 8ns (2.5Gbps).



# System Design

- Data Frame Format

1 byte	4 byte	8 byte
K28.3	address	data

4 bytes for address; 8 bytes for data; 1 byte for K28.3  
The maximum data transfer rate is 76.9MB/s (2.5Gbps)



# Hardware list

- SINAP v2 timing system:
  - VME-EVO
  - VME-EVE
  - PLC-EVR
  - STD-OE



# VME-EVO

Configured to EVG, EVR and FANOUT by software

VME 6U module, A16D32 addressing

Input: 1 RF clock (0 – 10dBm)

1 interlock / AC-line (TTL)

1 fiber (SFP module)

Output: 8 fiber (SFP module)

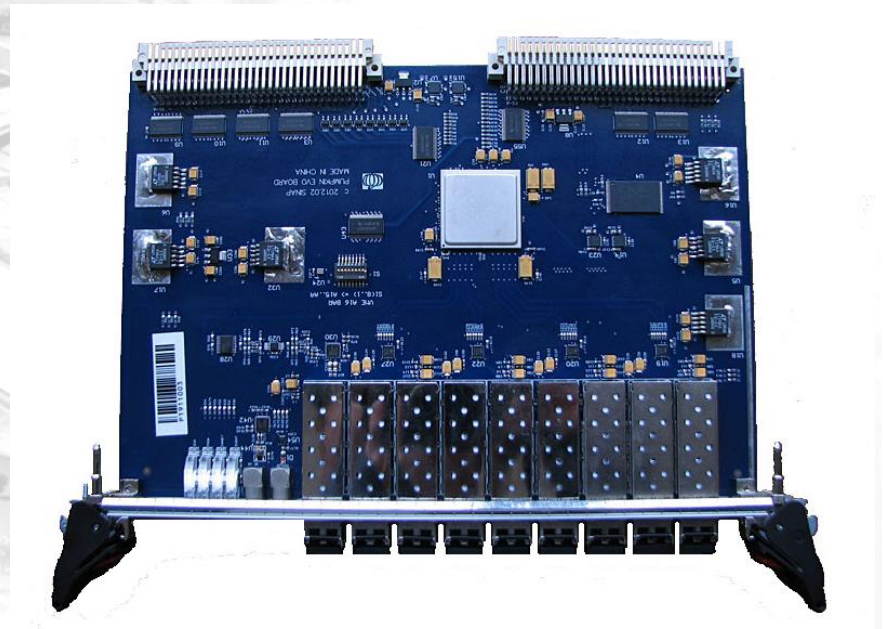

# VME-EVO

- Configure to EVG

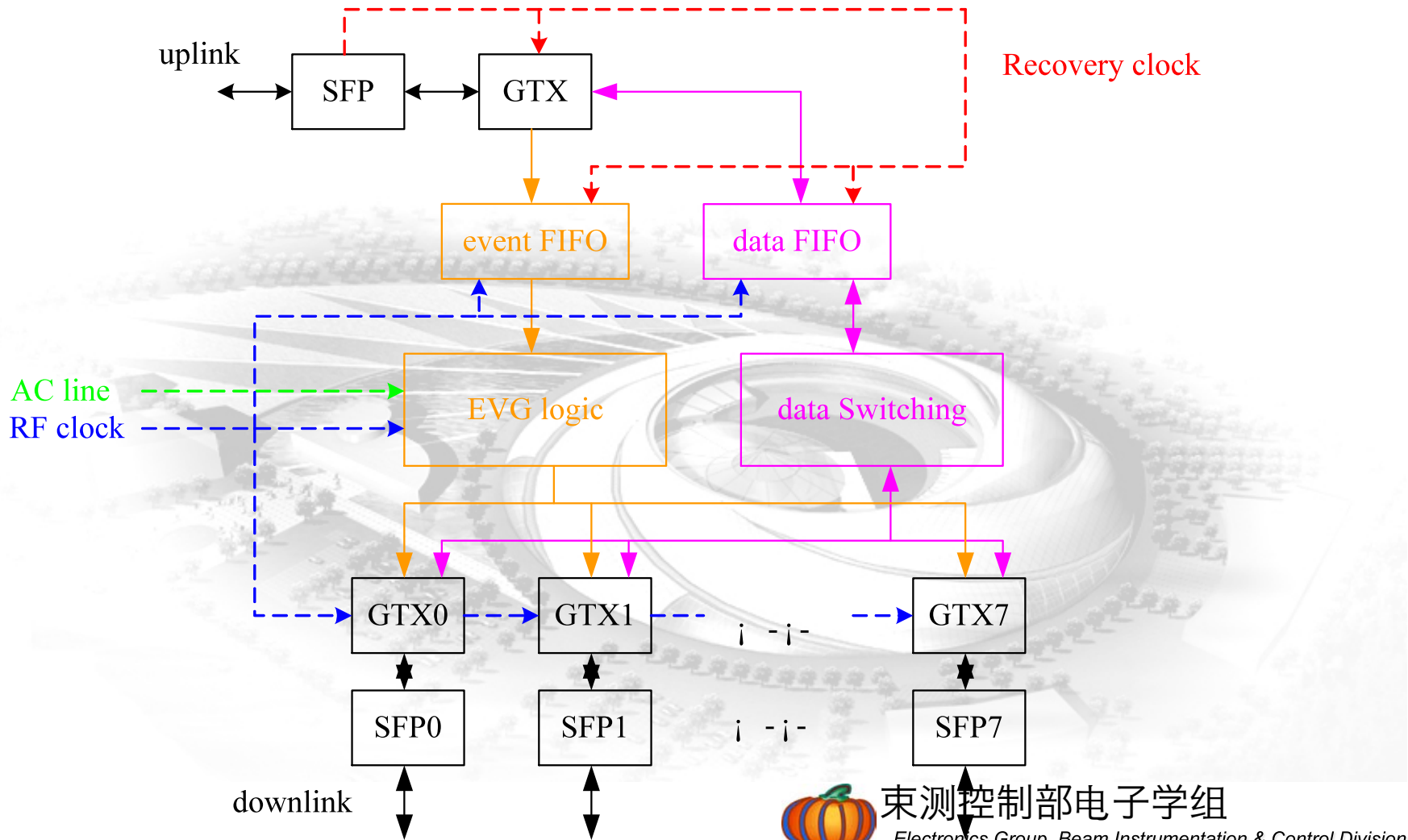

# VME-EVO

- Configure to FANOUT

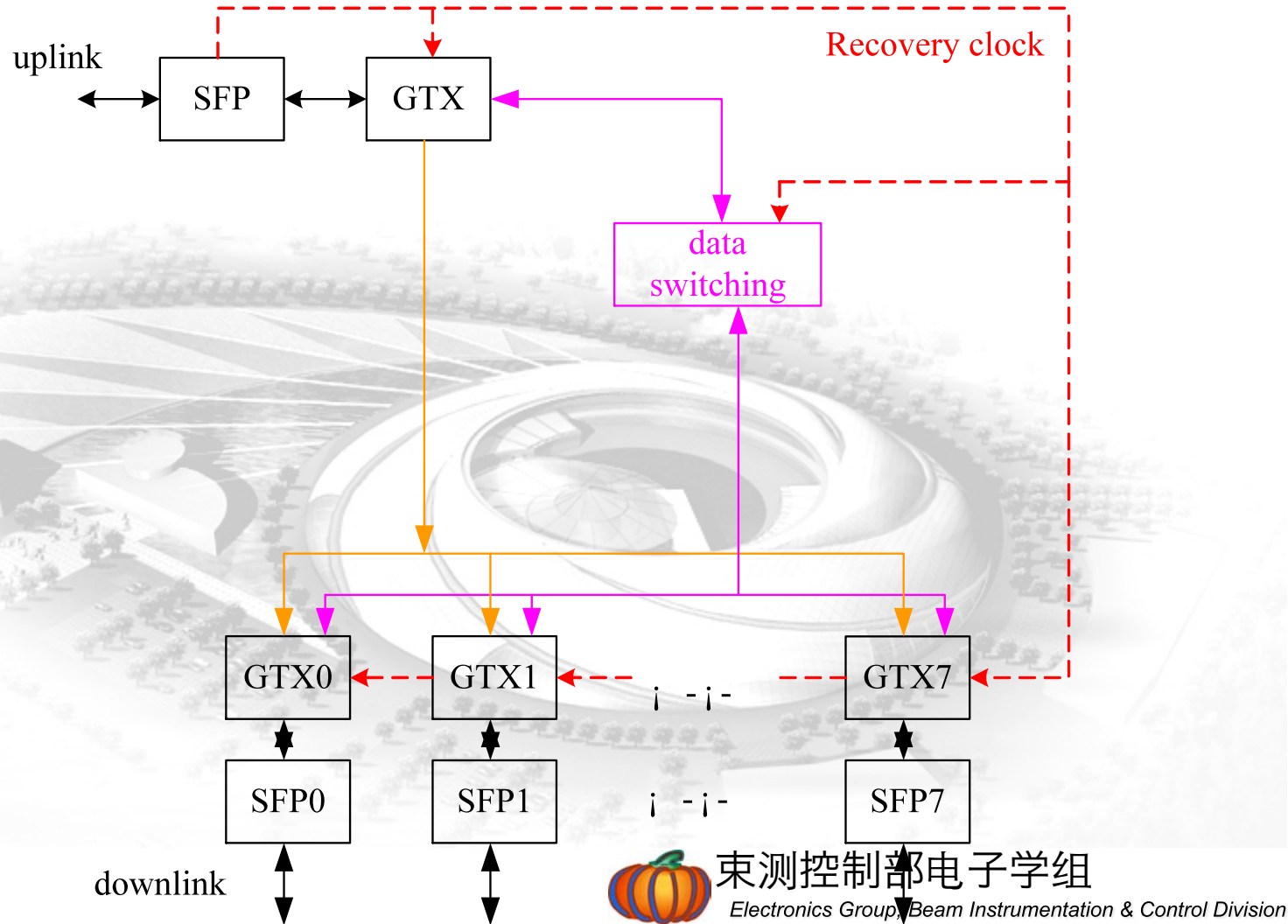

# VME-EVO

- Configure to EVR

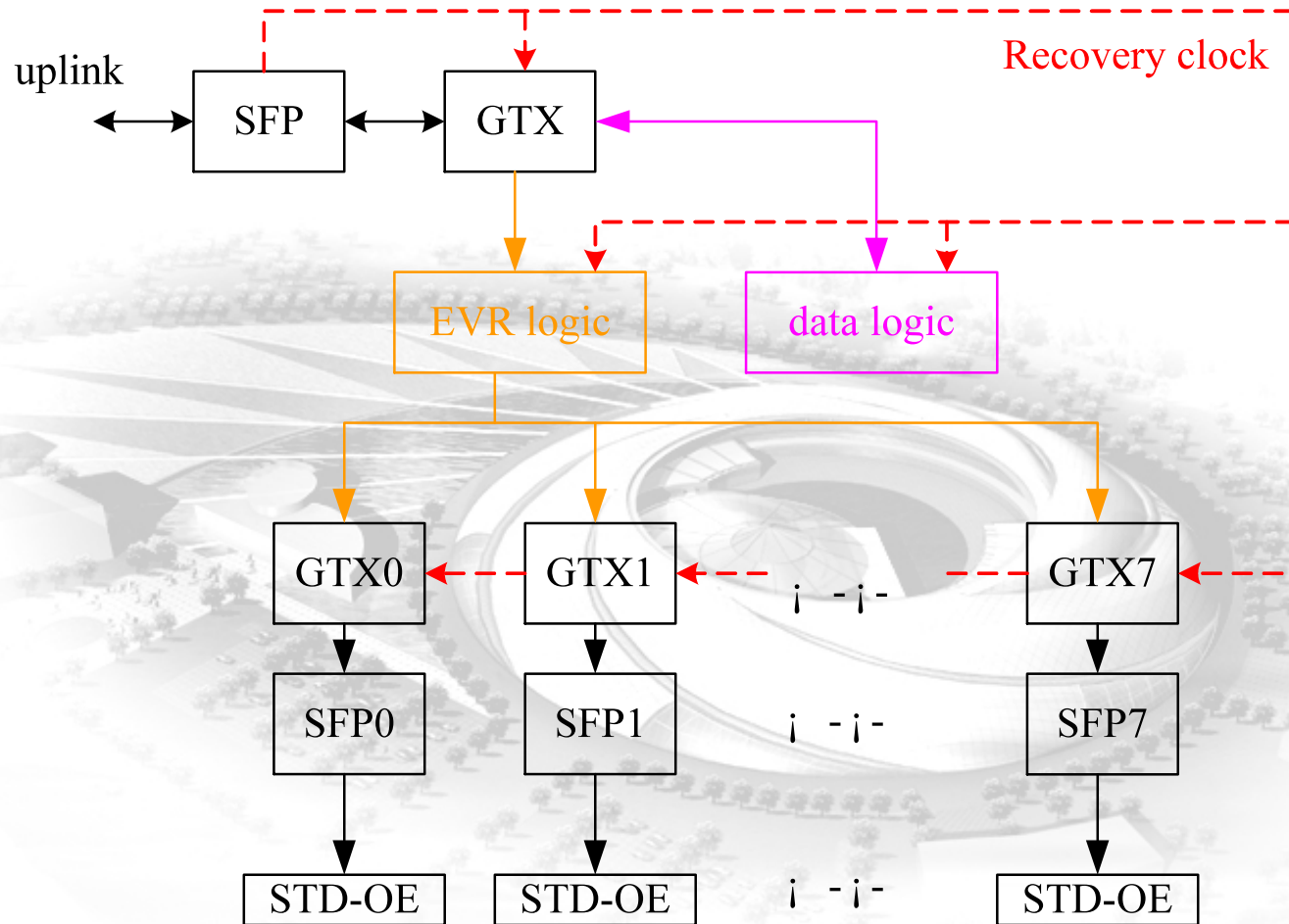

# VME-EVE

Configured to EVR

VME 6U module, A16D32 addressing

Input: 1 interlock (TTL)

1 fiber (SFP module)

Output: 8 outputs (TTL)

1 RF recovery clock

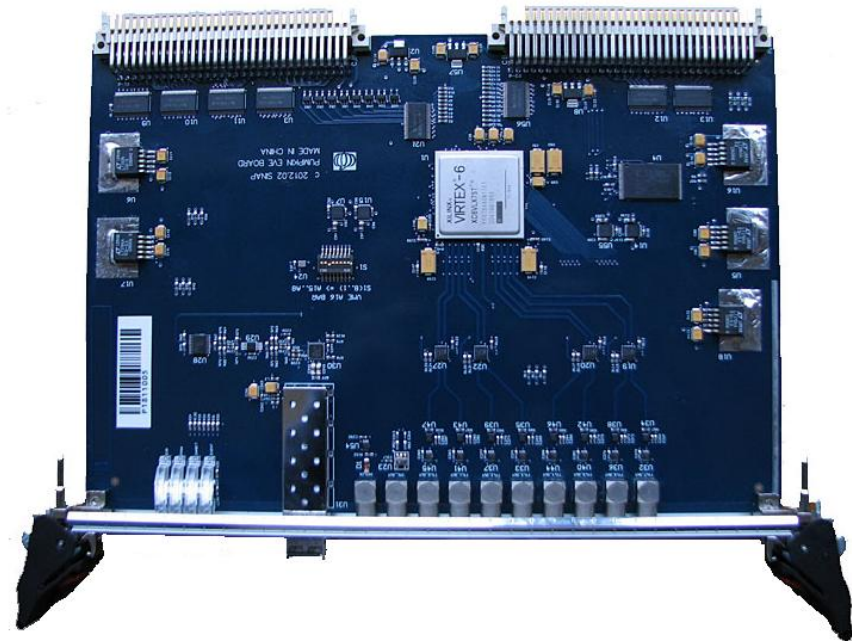

# VME-EVE

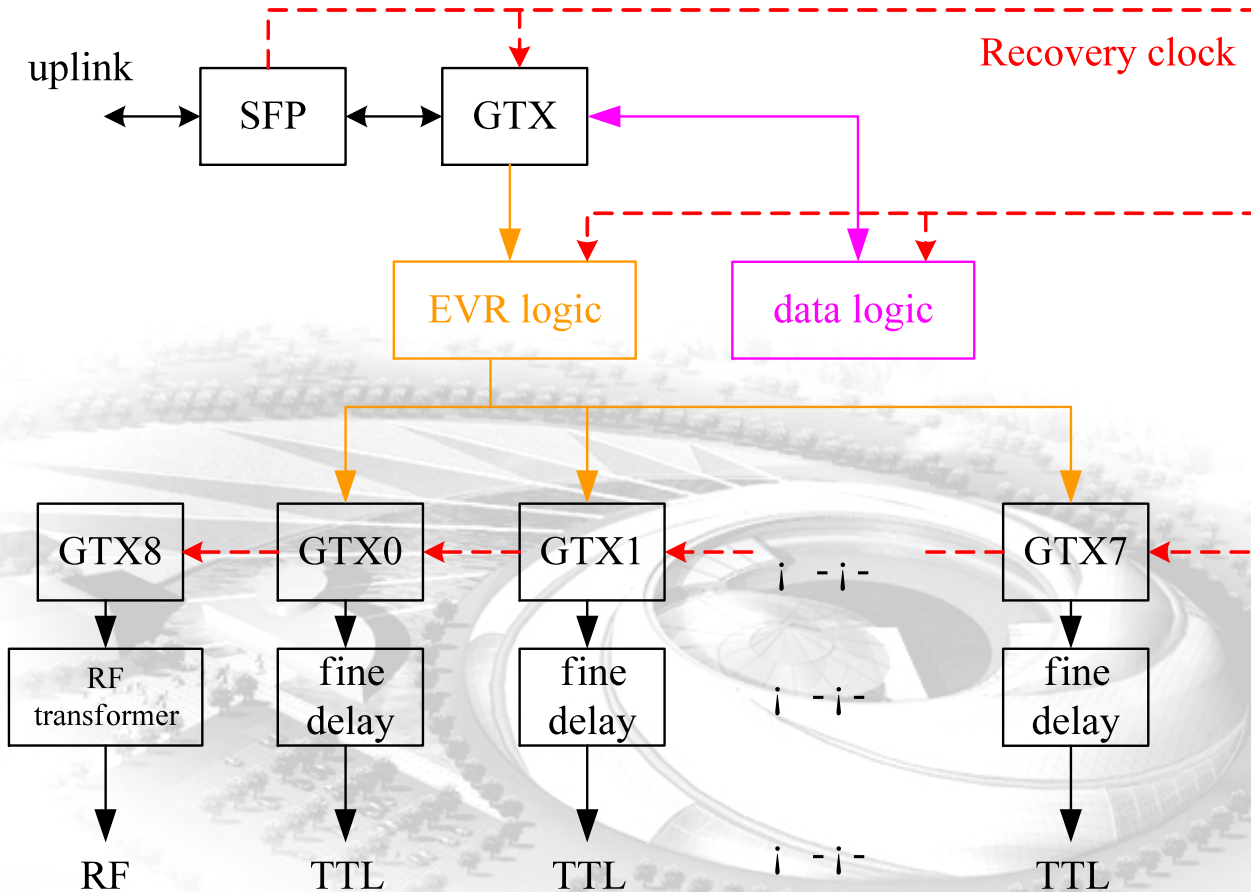

# VME-EVE

- RF recovery clock

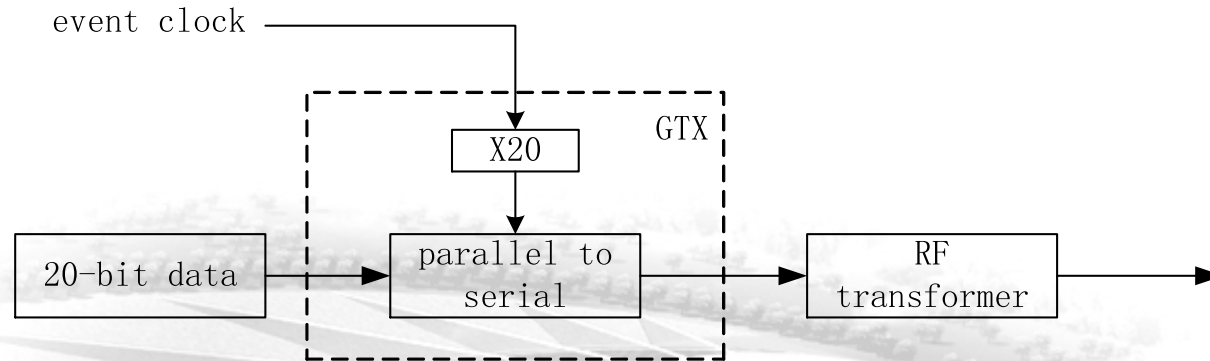

0x003ff -> event clock

0x03c1f -> 2x event clock

0x18c63 -> 4x event clock

...





# VME-EVE

- RF delay

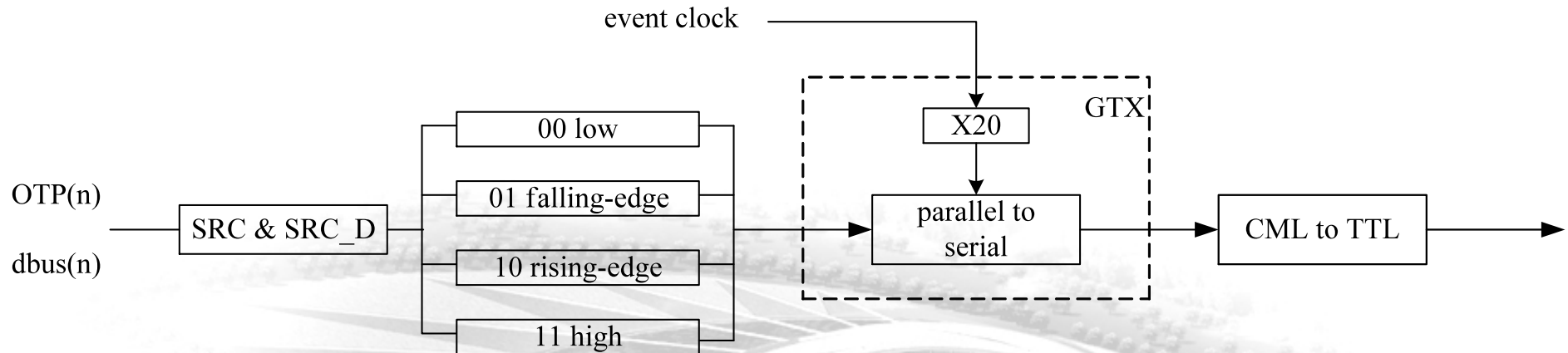

(0,0,0xffff,0xffff) -> (0,0x1,0xffffe,0xffff)

1/20 event clock delay

(Synchronized with RF clock)



# PLC-EVR

Yokogawa FAM3 series, 1-slot module

Input/Output register mode

external 5V/3A DC power supply is required

Input: 1 fiber (SFP module)

Output: 4 outputs (TTL)



# STD-OE

19 inches 1U standard chassis

110/220V 50-60Hz AC power supply

Input: 4 fiber (SFP module)

Output: 4 outputs (TTL)

