

S-band RF gun based on new type accelerating structure

A.M. Barnyakov, D.A. Nikiforov, A.E. Levichev

Accelerator seminar

KEK-BINP

26.10.2017

nikdanila@bk.ru

Outline

- Motivation and requirements
- Typical RF gun parameters
- Parallel coupling accelerating structure (PCAS)
- Beam dynamics for SUPER c-tau
- Beam dynamics for FCC
- Prototype of parallel coupled accelerating structure
- Ir5Ce Cathode
- Conclusion

Motivation

Photocathode rf guns are considering today as the most advanced type of electron injectors for modern electron-positron colliders.

Super KEKB (Japan)

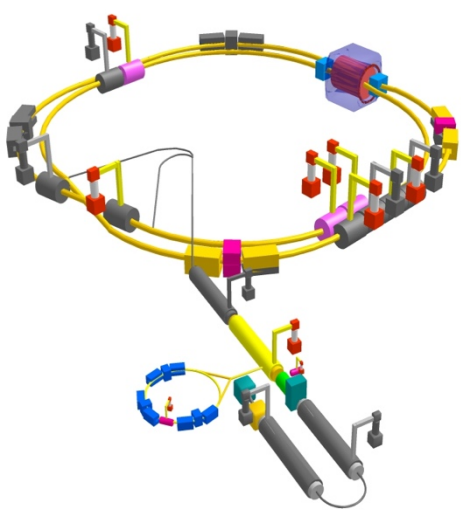

FCC (CERN)

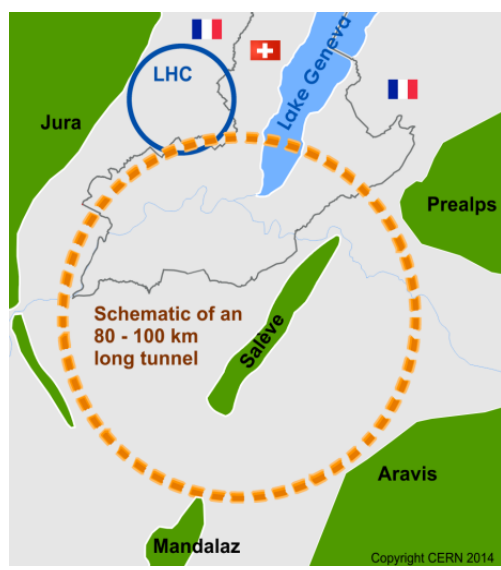

Super-c- τ -factory (BINP)

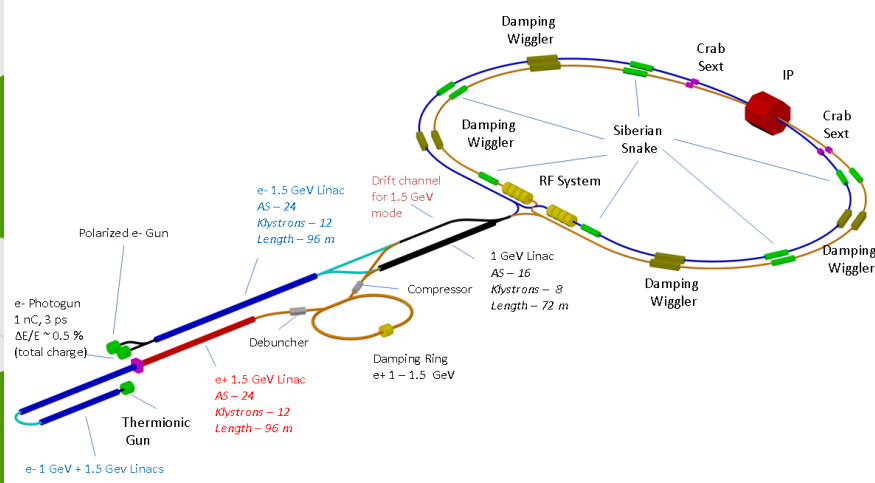

High charge and low emittance are needed!

Motivation and requirements

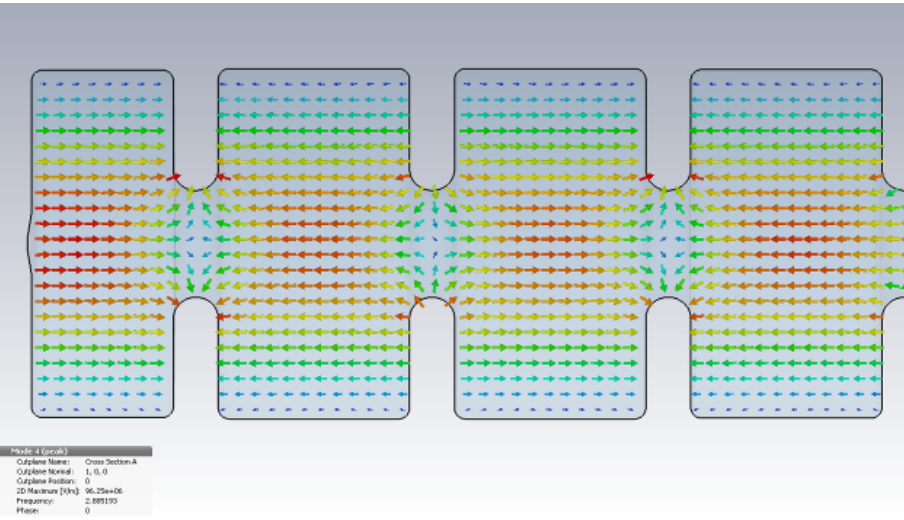

Beam envelope along the gun

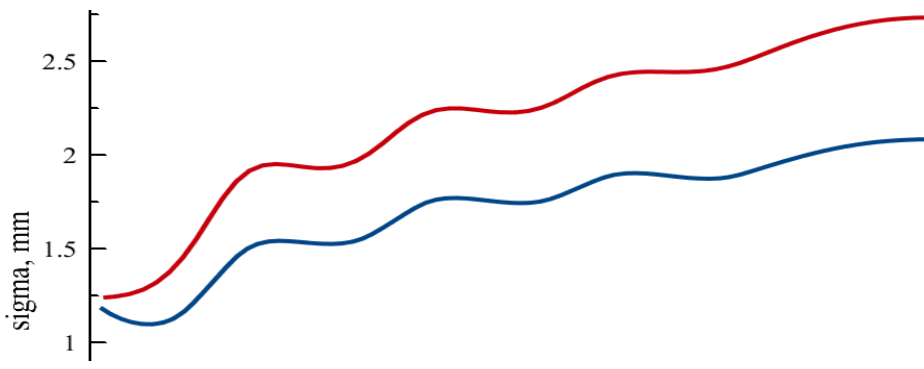

In the last cell beam can occupy a half of aperture

Electric field on axis

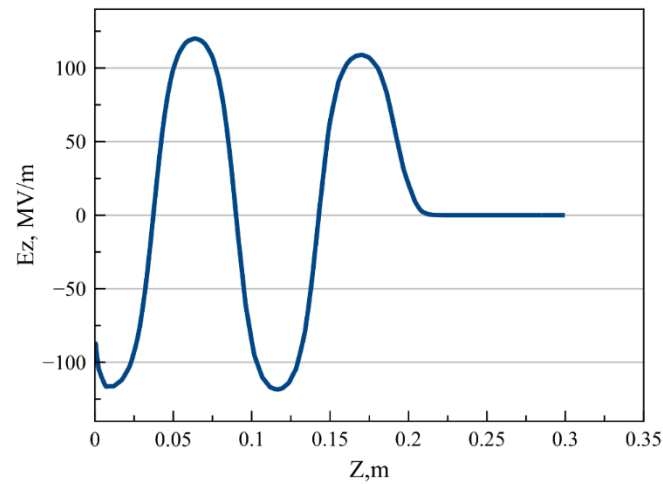

Distribution of the vertical electrical field component near the beam axis

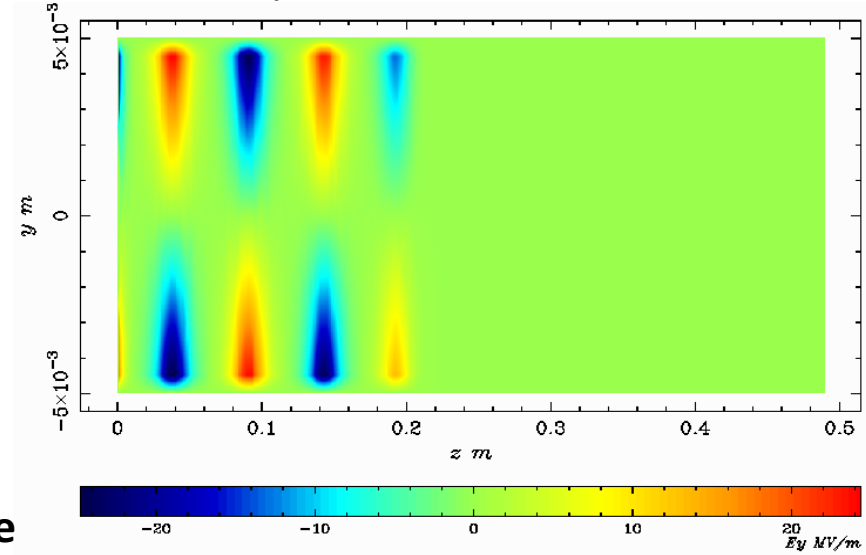

Motivation and requirements

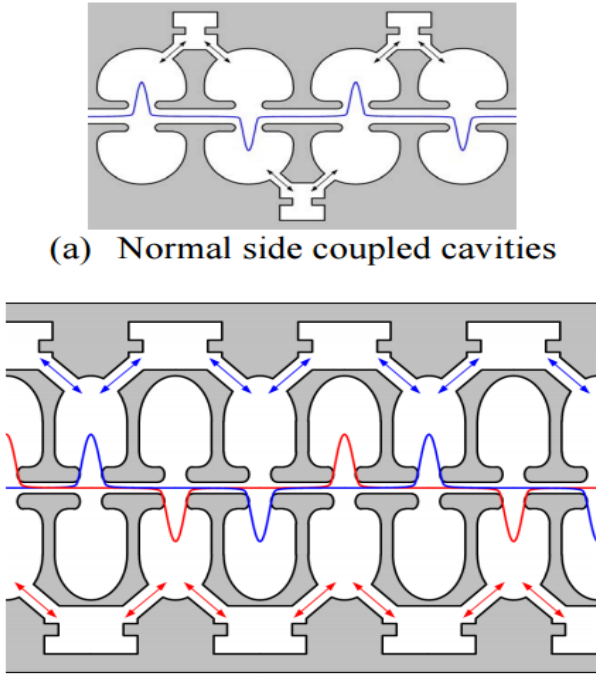

(a) Normal side coupled cavities

(b) Quasi traveling wave side coupled cavity

Figure 1: Structure of the quasi traveling wave ca

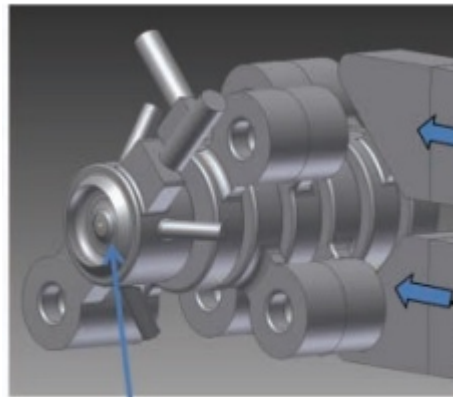
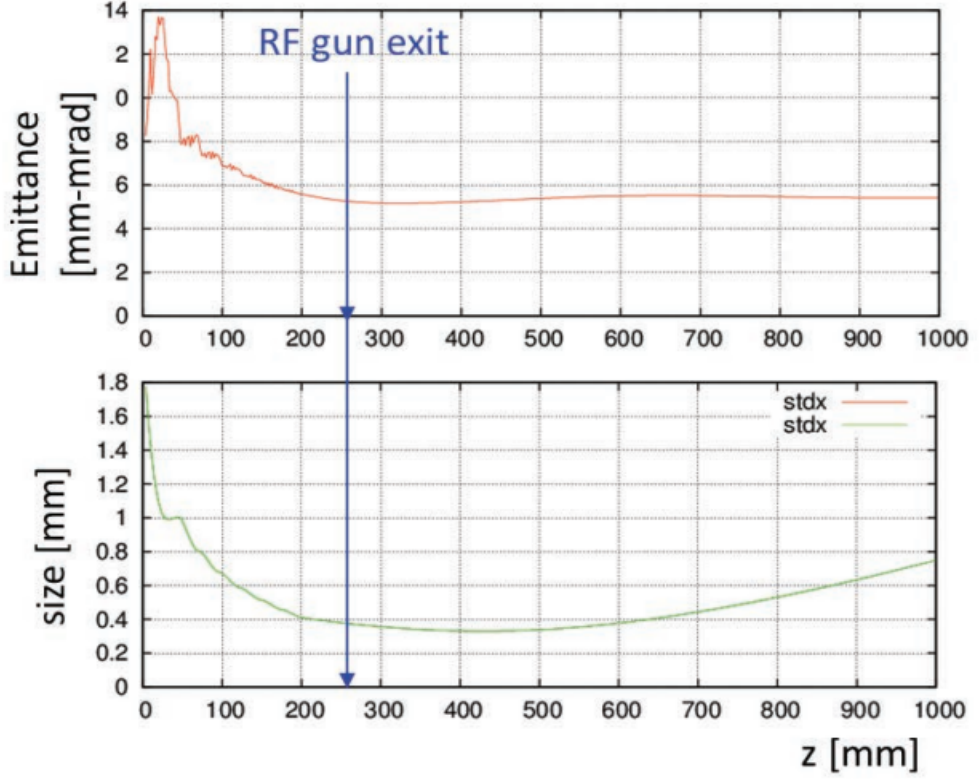

cathode



Ir₅Ce Cathode
QE=1 × 10⁻⁴ @266nm
Long lifetime

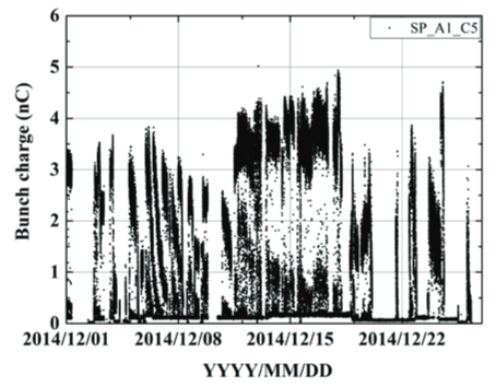
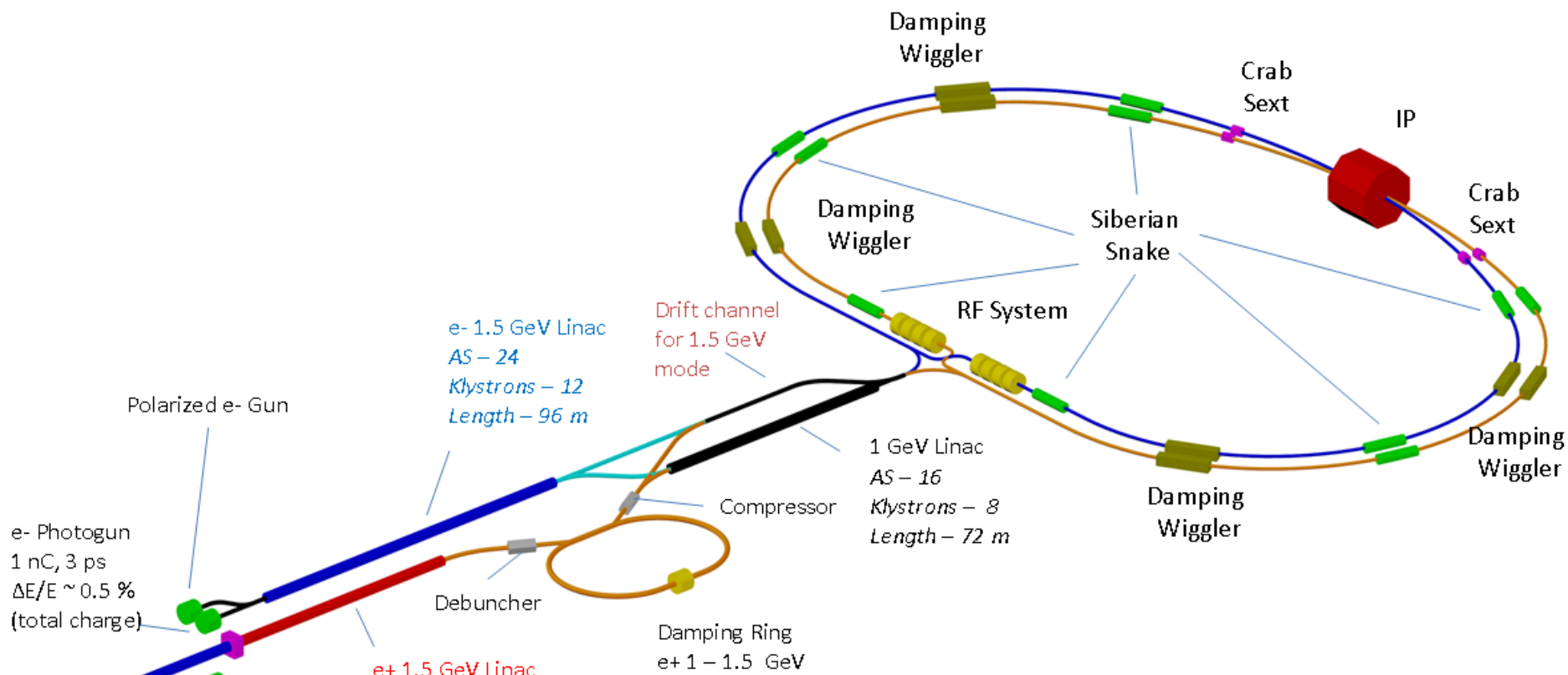

Figure 6: Beam charge of RF gun.

Motivation and requirements



Main parameters of Super C-tau Injector Linac

Beam energy (GeV)	1.5-2.5
Bunch charge e-/e+ (nC)	1.5/3.5
Norm. emittance (pi mm mrad)	<10 pi mm mrad
Energy spread	<1%

Typical RF gun parameters

Parameters	Value
Energy (MeV)	9-11
Charge (nC)	6.5 (FCC*), 1.5 (Super c-tau)
Horizontal emittance (mm mrad)	<6 (FCC), <10(Super c-tau)
Vertical emittance (mm mrad)	<10(FCC), <10 (Super c-tau)
Longitudinal sigma (mm)	~1.3
Transverse sigma (mm)	1-2
RMS Energy spread	<1%

- To extract such a big charge, beam size will be too large , due to space charge limit (several mm)
- Focusing magnetic field along the cavities or/ strong RF focusing are needed to preserve or decrease transverse beam dimensions.

* - **PRELIMINARY**

Parallel coupling accelerating structure (PCAS)

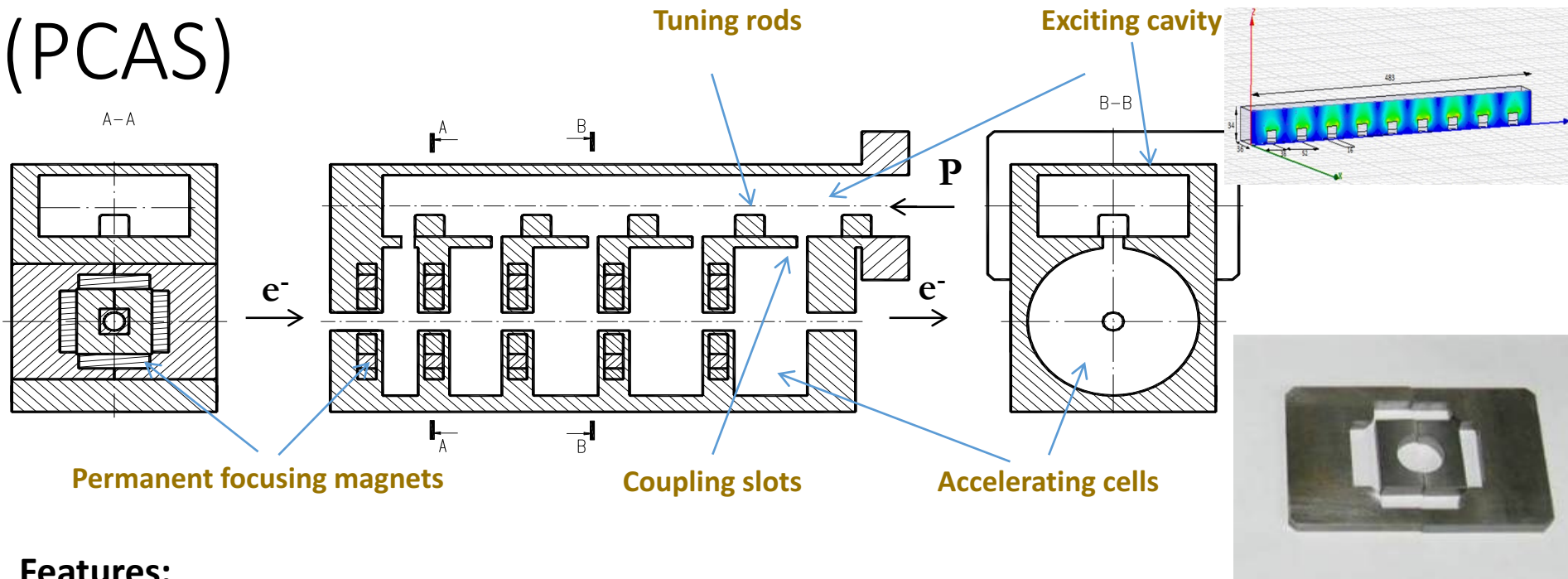

Features:

- 1) Parallel RF power feeding.
- 2) Cavities are not connected with each other by RF power: process in one cavity doesn't influence on every cavities
- 3) Organization of the free electric field distribution along the structure can be obtained by changing the individual coupling slot
- 4) In order to develop accelerating structure only one accelerating cells have to be calculated due to absence of the cavities connection by electromagnetic field
- 5) Aperture of the structure is defined by only beam motion and can be considerably reduced
- 6) **Design of the structure allows using internal permanent focusing magnets.**

For more details of PCAS excitation you can see:

Chernousov Yu D., Ivannikov V. I., Shebolaev I. V., Levichev A. E., Pavlov V. M.. Bandpass characteristics of coupled resonators. JOURNAL OF COMMUNICATIONS TECHNOLOGY AND ELECTRONICS, Volume 55, Issue 8, pp. 863-869. DOI: 10.1134/S1064226910080036.

Published: AUG 2010

A. M. Barnyakov, A. E. Levichev, D. A. Nikiforov.. Intercavity Coupling Constant of the Cavities. Journal of Communications Technology and Electronics, 2016, Vol. 61, No. 7, pp. 783-788

RF gun based on (PCAS)

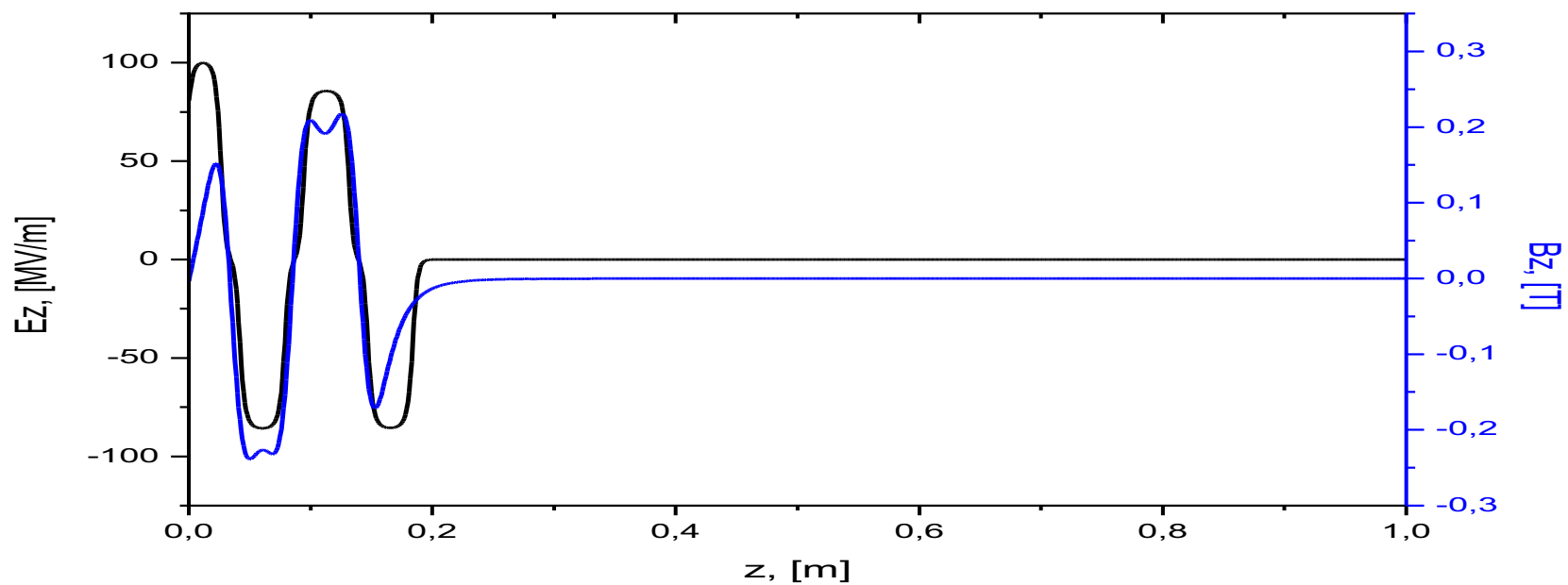
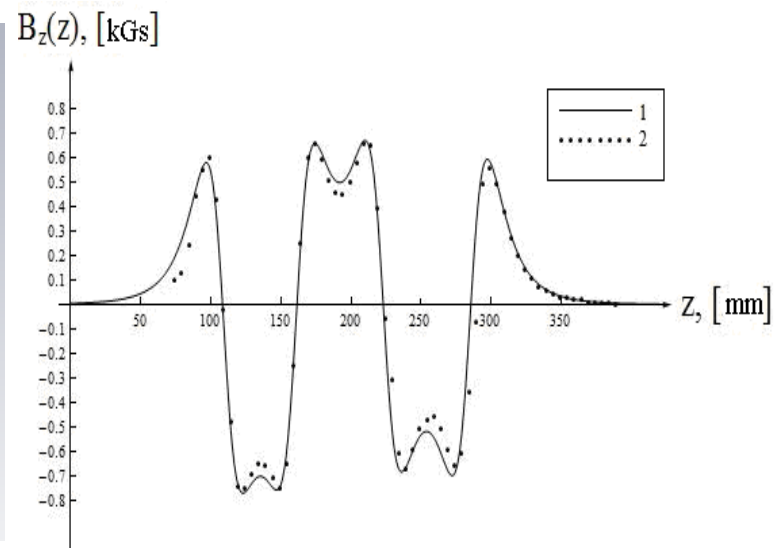
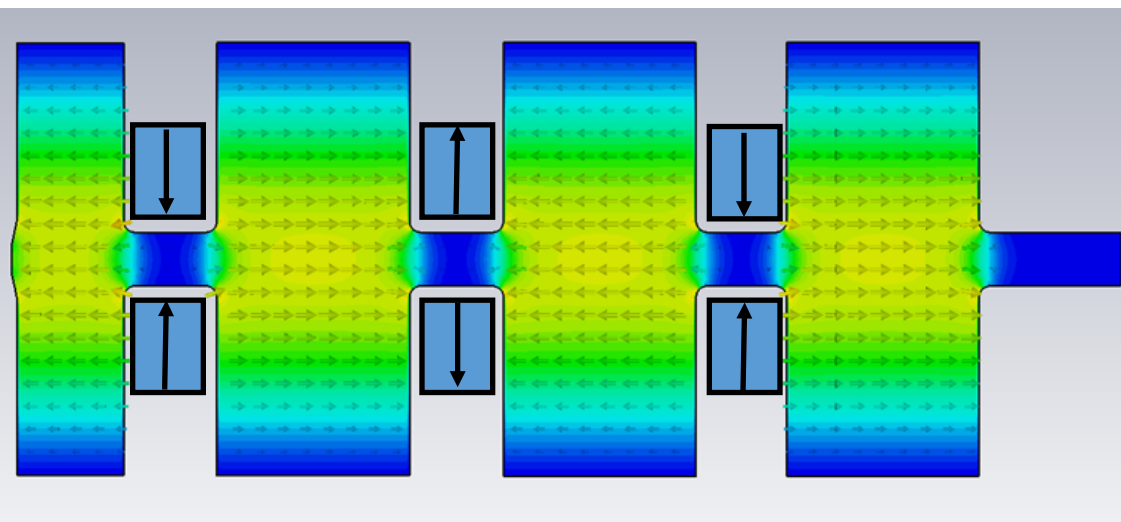

Beam dynamics for SUPER c-tau

ASTRA simulation parameters	
Initial emittance	0.6 mm mrad
Initial kinetic energy	0.6 eV
Total charge	1.5 nC
Cathode spot size	3 mm
Initial distribution	Rad. Uniform
Laser pulse duration	10 ps
Laser injection phase	variable
Magnetic field on the cathode	0 T
Peak accelerating field	70 MV/m
Focusing solenoid field	0.35 T

Beam dynamics for SUPER c-tau factory

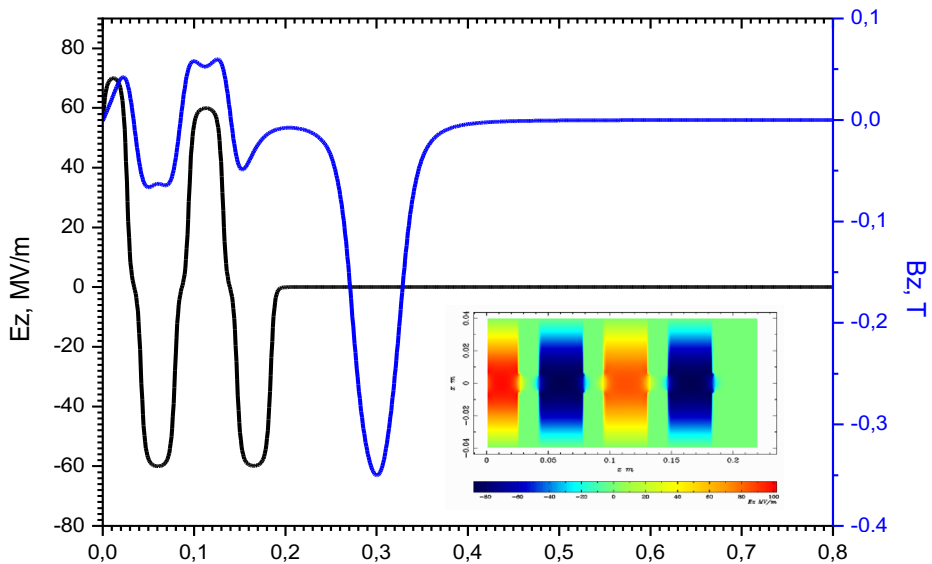

Parameter	Value
Beam length (sigma, mm)	1.5
Norm tr. Emittance (mm mrad)	2.3
Energy (MeV)	6.5
Energy spread (%)	~1%
Injection phase (deg)	200

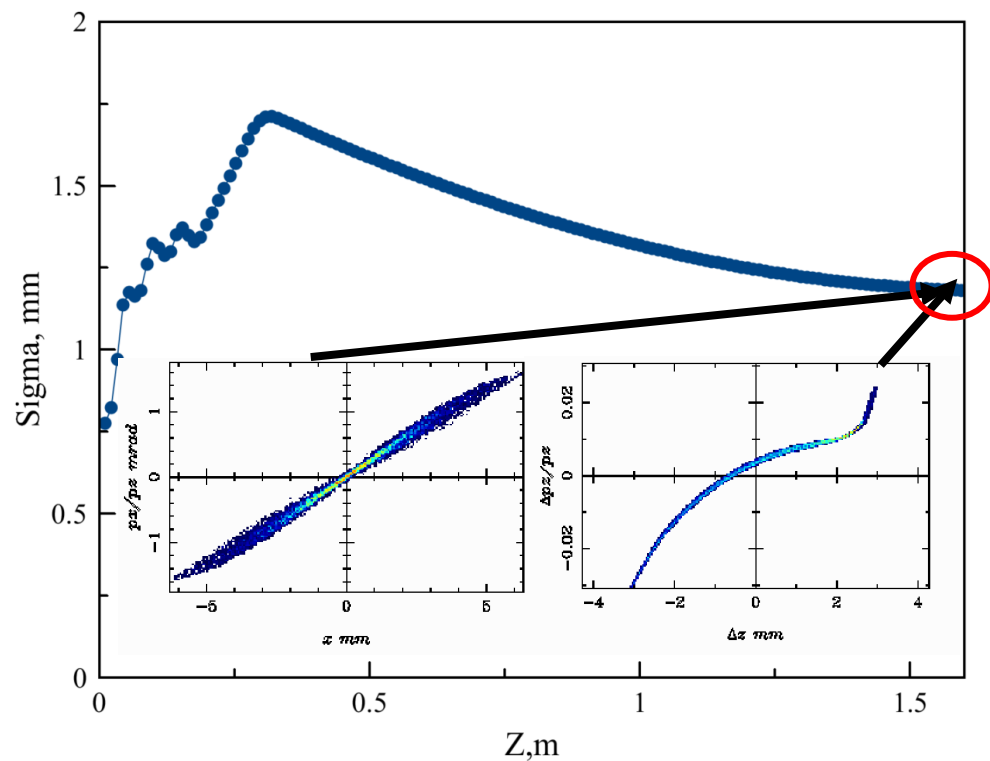
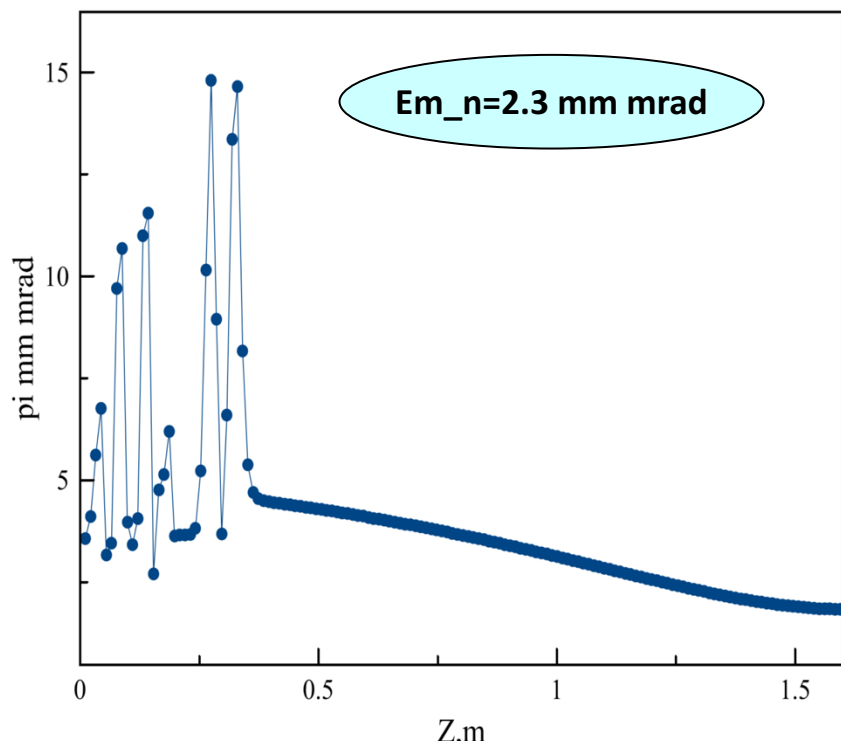

Beam dynamics for FCC

ASTRA simulation parameters	
Initial emittance	0.6 mm mrad
Initial kinetic energy	0.6 eV
Total charge	6.5 nC
Cathode spot size	5 mm
Initial distribution	Rad. Uniform
Laser pulse duration	14 ps
Laser injection phase	variable
Magnetic field on the cathode	0 T
Peak accelerating field	100 MV/m
Focusing solenoid field	0.5 T

Beam dynamics for FCC

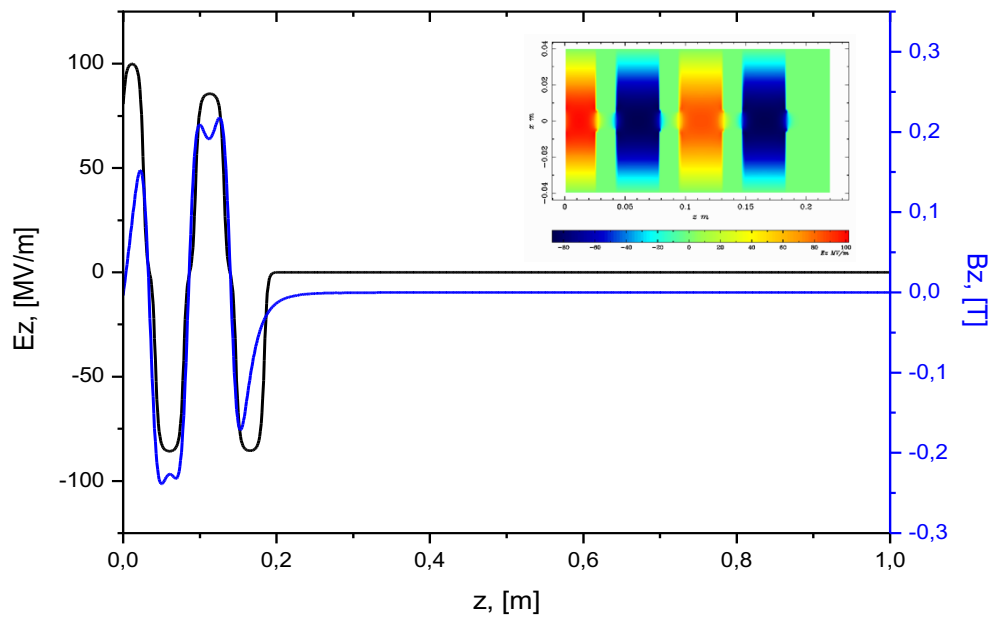

Parameter	Value
Beam length (sigma, mm)	1.5
Norm tr. Emittance (mm mrad)	3
Energy (MeV)	9.8
Energy spread (%)	~1%
Injection phase (deg)	200

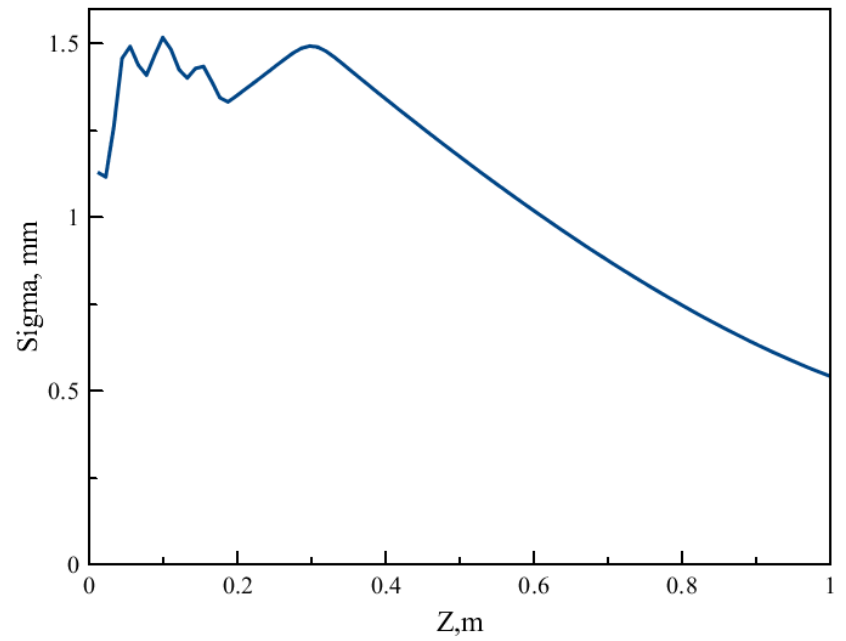
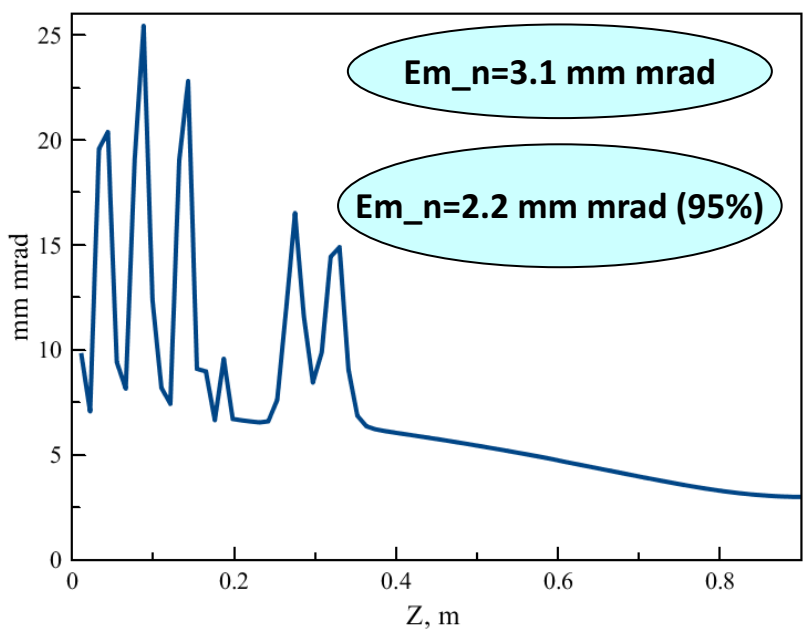

Beam dynamics for FCC

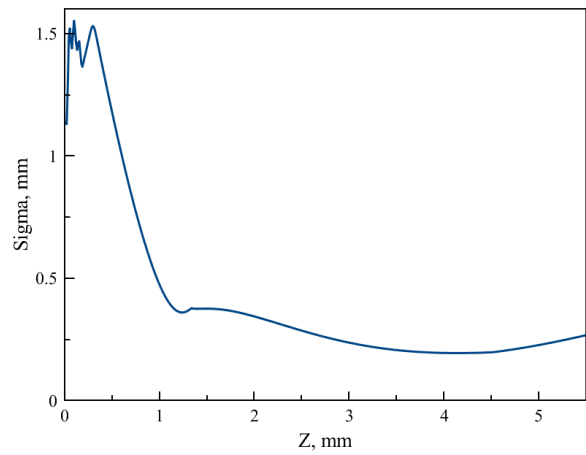
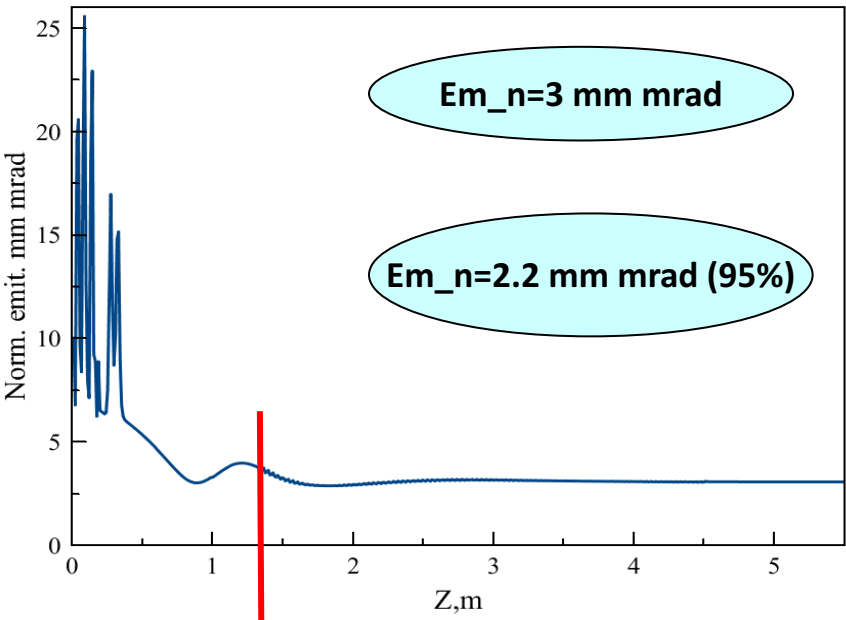
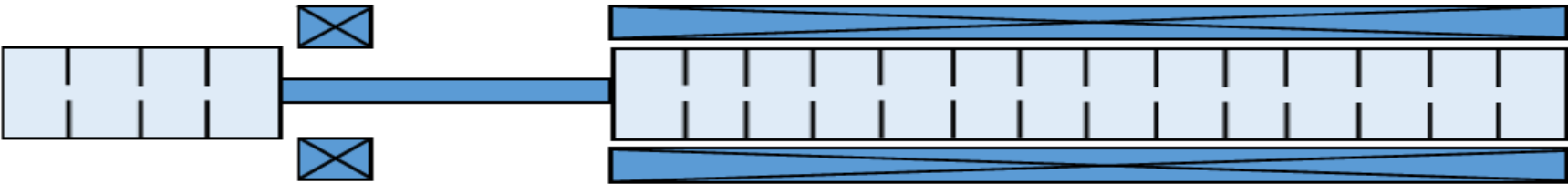

3 m. long SLAC type acc. structure

Parameter	Value
Beam length (sigma, mm)	1.5
Norm tr. Emittance (mm mrad)	3
Energy (MeV)	9.8
Energy spread (%)	0.7%
Injection phase (deg)	293

Prototype of parallel coupled accelerating structure with 2450 MHz

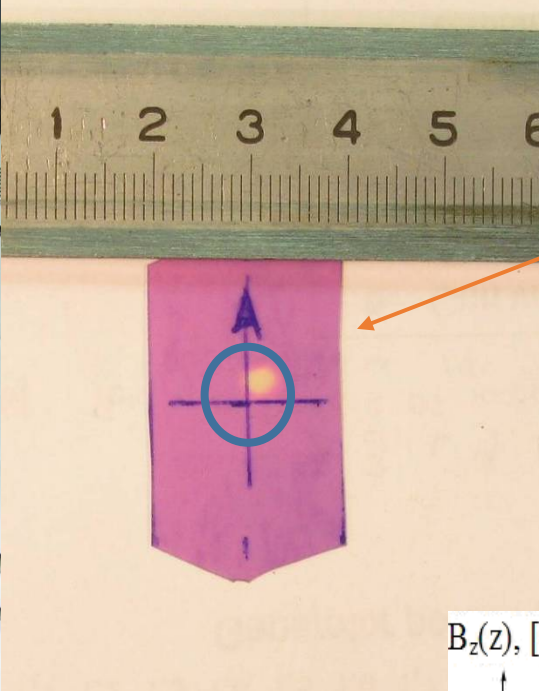
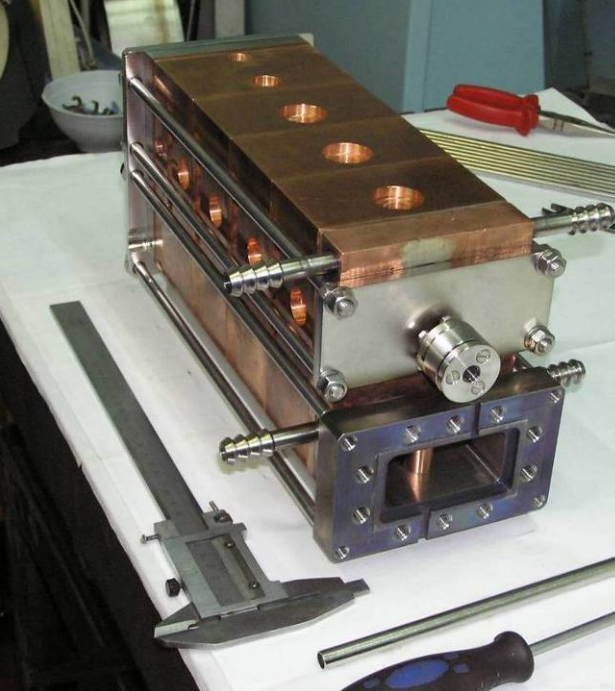

Beam current of 300 mA in the end of accelerating structure, duration is 2.5 ns (half of pulse), energy is about 4 MeV

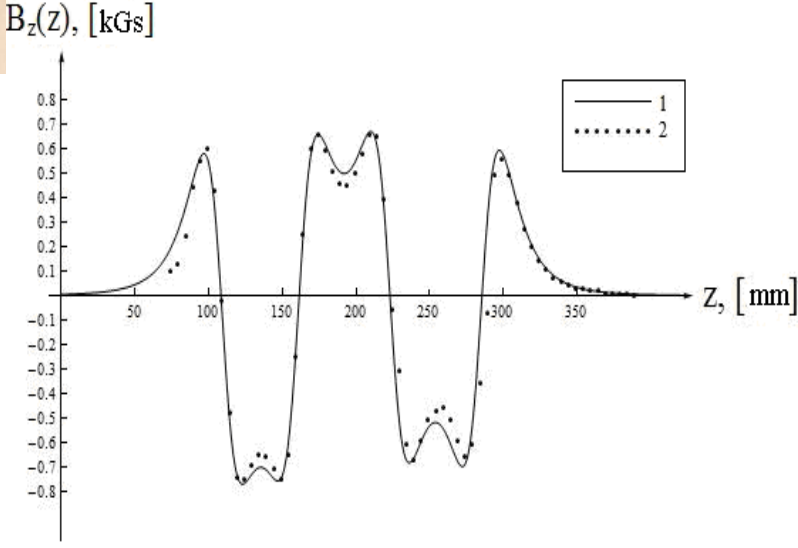
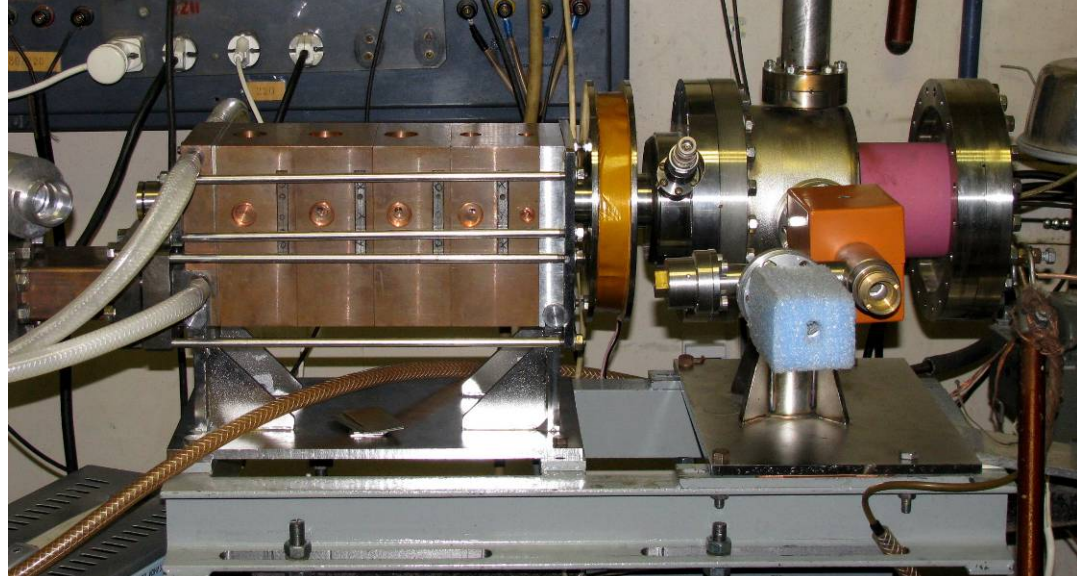

Measured and calculated magnetic field from the permanent magnets

Prototype of parallel coupled accelerating structure with 2450 MHz: breakdowns

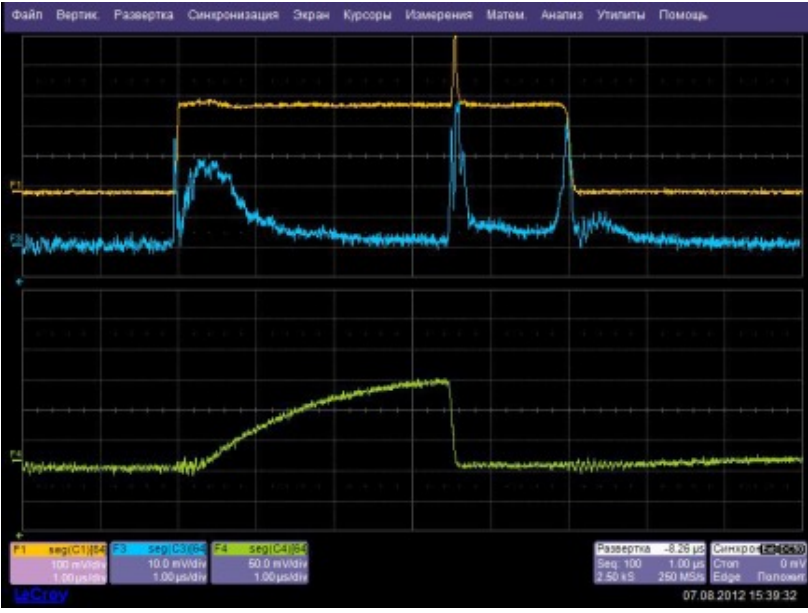

Breakdown in the 5-th accelerating cavity. yellow – RF power from klystron, 1.6 MW, pulse duration 5 μ s; blue – reflected signal; green – stored RF energy in 5-th accelerating cavity

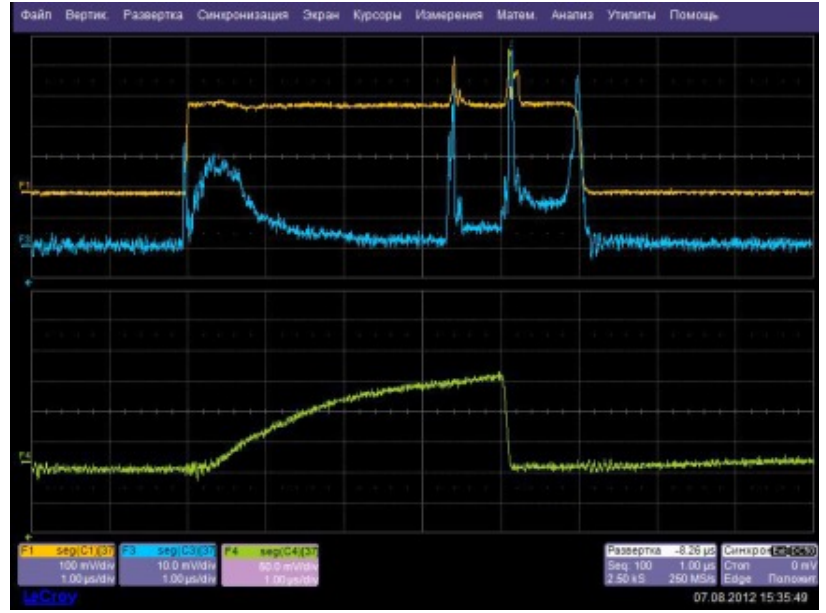

Regime with breakdowns in several accelerating cavities. F1 – RF power from klystron, 1.6 MW, pulse duration 5 μ s; F3 – reflected signal; F4 – stored RF energy in 5-th accelerating cavity

The peak on the reflected signal (blue) corresponds to the breakdown in one of the accelerating cavities. One can see that only cavity with breakdown is “switched off”. On the left figure the first breakdown is in the fifth cavity and the its storage energy is terminated. On the right figure the first breakdown doesn’t influence on the fifth accelerating cavity.

Prototype of parallel coupled accelerating structure with 2450 MHz:
after a few years of operating



After a few years of operating the structure were disassembled. Further, the cavities were tuned, assembled. The structure is working now.

Prototype of parallel coupled accelerating structure with 2856 MHz

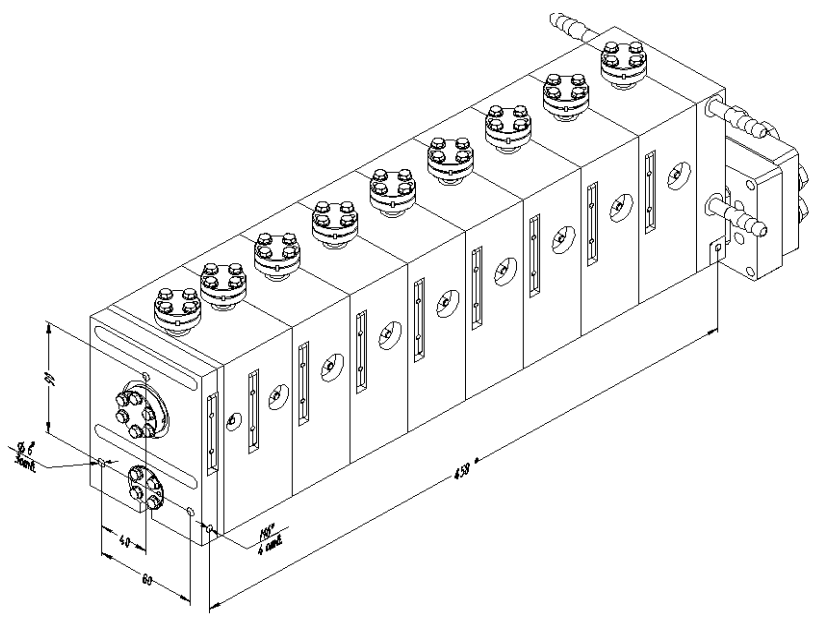
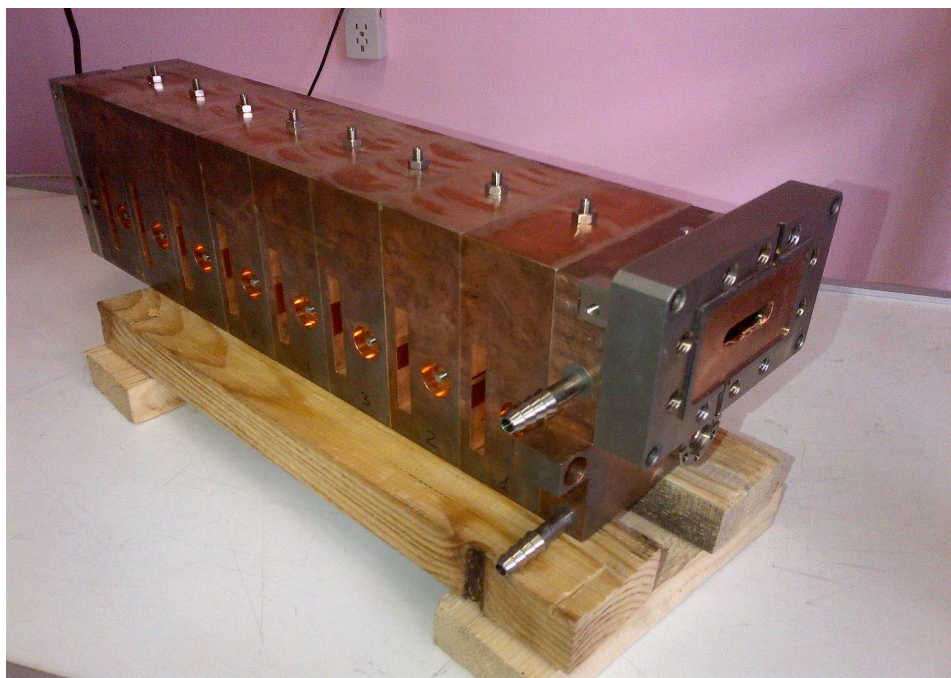
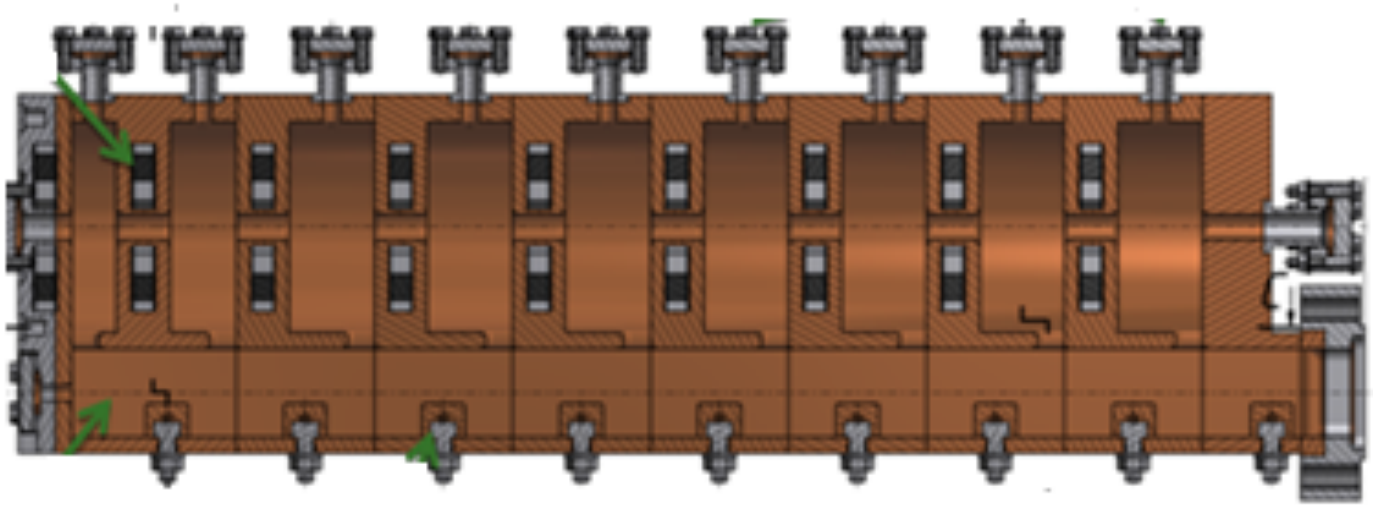

Ir₅Ce and LaB₆ as a Photocathode

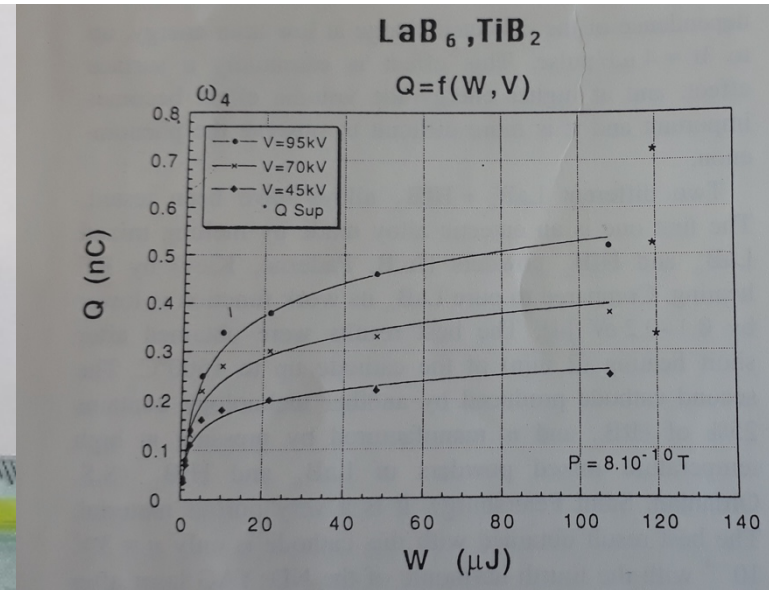

Ir₅Ce cathodes for Korean EBIS (left) and for BNL EBIS (right) was produced and tested at BINP (G. Kuznetsov)

In cooperation with institute of Laser physics SB RAS we are going to make a stress test and investigate the life time of such a cathodes

Conclusion

1. The design of parallel coupled accelerating structure allows using the permanent focusing magnets and create the strong magnetic field along the cavities and save the beam size.
2. The travelling tube aperture can be decreased as significantly as it allows the beam dynamics.
3. This design of the RF gun allows us to consider the cavities as independent. The length and field amplitude can be tuned separately for every cavity.
4. Preliminary results of beam dynamic simulations gave reason to hope that this construction is acceptable solution for high charge generation.
5. The prototype of the accelerating structure based on new design with parallel coupling between the cavities have been produced in BINP with operating frequency of 2450 MHz and successfully tested.
6. It is currently planned to perform tests the new parallel coupled accelerating structure with 2856 MHz .

But:

- 1. More investigations for high power operation mode are needed**

Possible cooperation

- The procedure of manufacturing, tuning and measurement of PCAS is well established at BINP.
- There is good experience of operation of such structure (especially with indium variant).
- At BINP we have a good experience of production and exploiting of high quality IrCe cathode with high current density and long lifetime.

But...

- For further testing of such a structure with high power and intense beam extraction, the klystron and laser system are needed.

And...

- KEK has a great experience of modern electron-positron injector development. BINP is very interesting in the possibility to adopt experience of KEK in this field.

References

- 1) H. A. Bethe, "Theory of Diffraction by Small Holes", Phys. Rev., Vol. 66, PP. 163-182, 1944.
- 2) Chernousov Yu.D., Ivannikov V. I., Shebolaev I.V., Levichev A. E., Pavlov V. M.. Bandpass characteristics of coupled resonators. JOURNAL OF COMMUNICATIONS TECHNOLOGY AND ELECTRONICS, Volume 55, Issue 8, pp. 863-869. DOI: 10.1134/S1064226910080036. Published: AUG 2010
- 3) Characteristics of the model of accelerator based on parallel coupled accelerating structure with beam loading. A.E. Levichev, V.M. Pavlov, V.I. Ivannikov, I.V. Shebolaev, Yu.D. Chernousov. Proceedings of RuPac 2012, JACoW publication, pp. 164-166
- 4) Localization of the RF breakdown in the parallel coupled accelerating structure. A.M. Barnyakov, A.E. Levichev, V.M. Pavlov, V.I. Ivannikov, I.V. Shebolaev, Yu.D. Chernousov. Proceedings of RuPac 2012, JACoW publication, pp. 281-283
- 5) Linear accelerator based on parallel coupled accelerating structure. A.E. Levichev, V.M. Pavlov, V.I. Ivannikov, I.V. Shebolaev, Yu.D. Chernousov. Proceedings of LINAC 2012, JACoW publication, pp. 282-284
- 6) A. Levichev, D. Nikiforov, A. Barnyakov, Yu. Chernousov, I. Shebolaev. Transient Process in a Parallel Coupled Accelerating System with Regard to Beam Current Loading. Technical Physics, 2015, Vol. 60, No. 1, pp. 137–140.
- 7) A. M. Barnyakov, A. E. Levichev, D. A. Nikiforov.. Intercavity Coupling Constant of the Cavities. Journal of Communications Technology and Electronics, 2016, Vol. 61, No. 7, pp. 783–788

Thank you for attention

Initial distribution

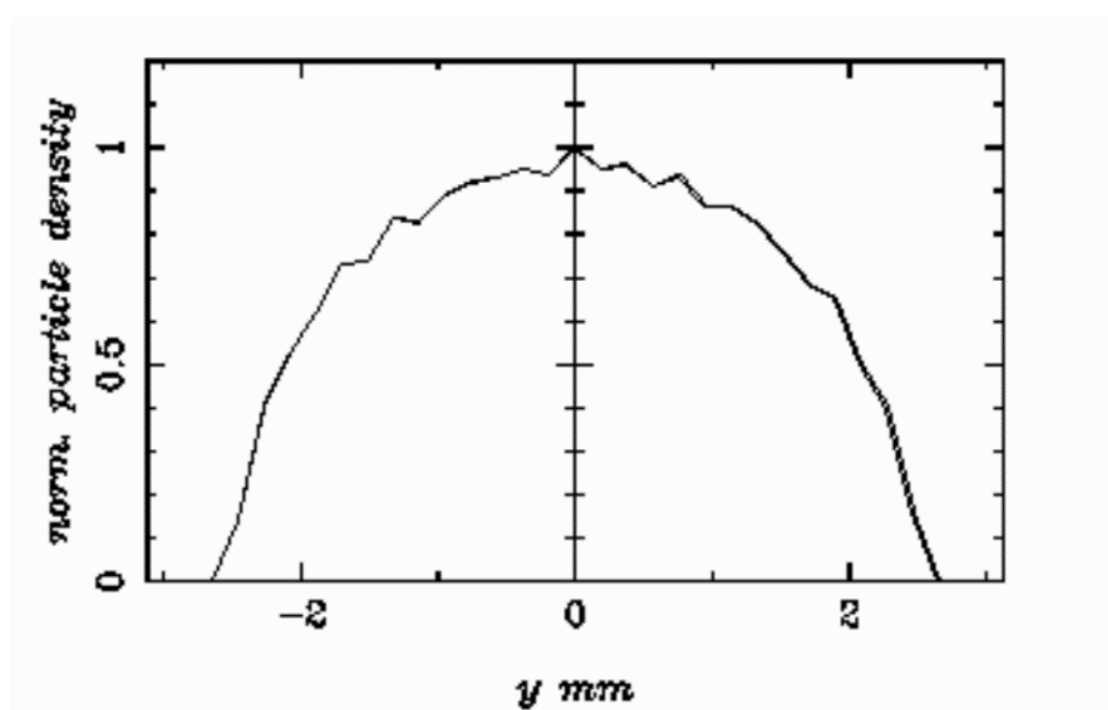

$$f(x, y) = \frac{1}{\pi r^2} \quad \text{for } x^2 + y^2 \leq r^2$$

$$0 \quad \text{elsewhere}$$

The projection onto the x-axis (eqv. y-axis) is a half ellipse

$$f(x) = 2 \int_0^{y_m} f(x, y) dy = \frac{2\sqrt{r^2 - x^2}}{\pi r^2} \quad |x| \leq r$$

Overvoltage factor

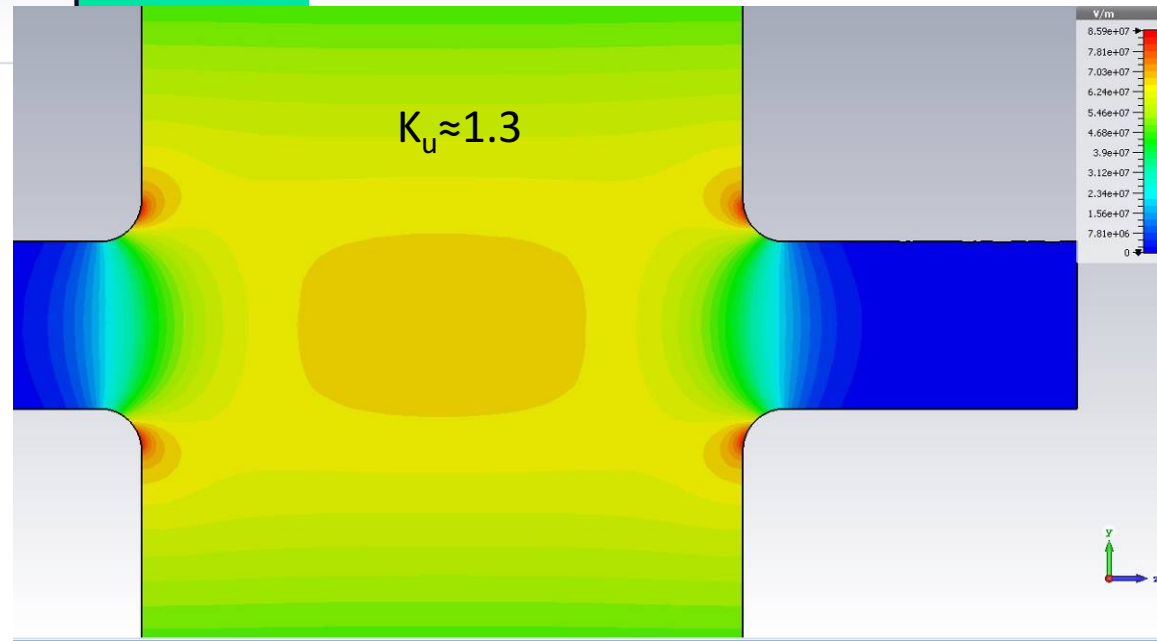
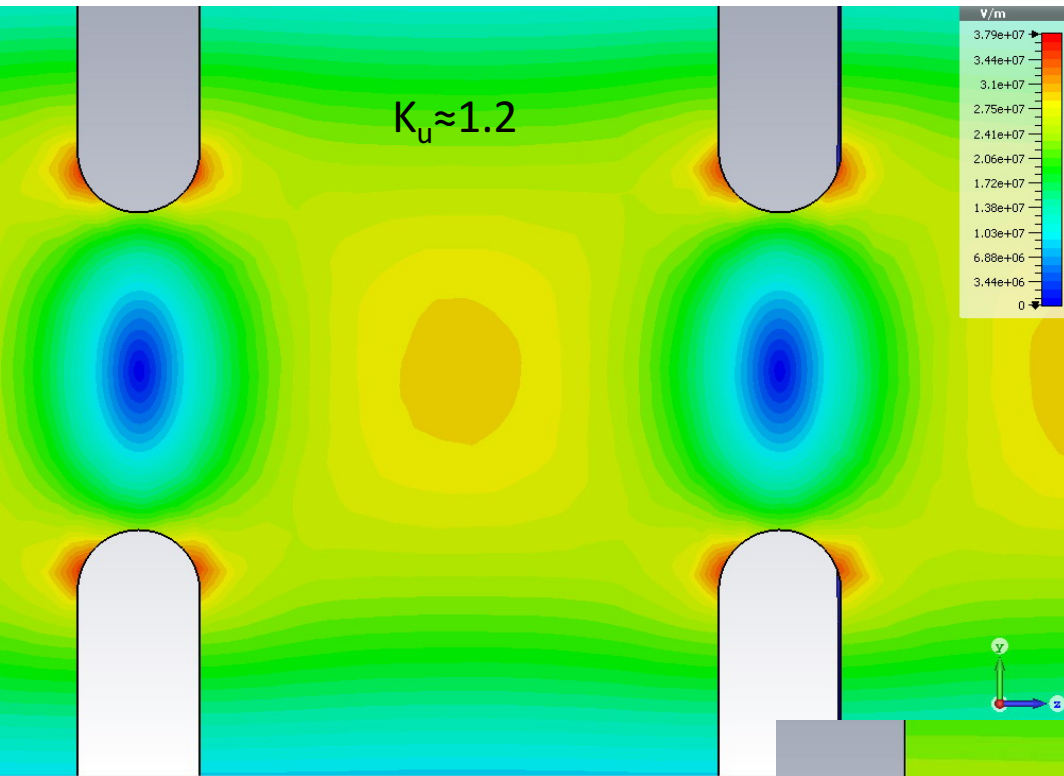

Overvoltage factor of PCAS is higher than for the ordinary structure. Shape of the cavities can be optimized.

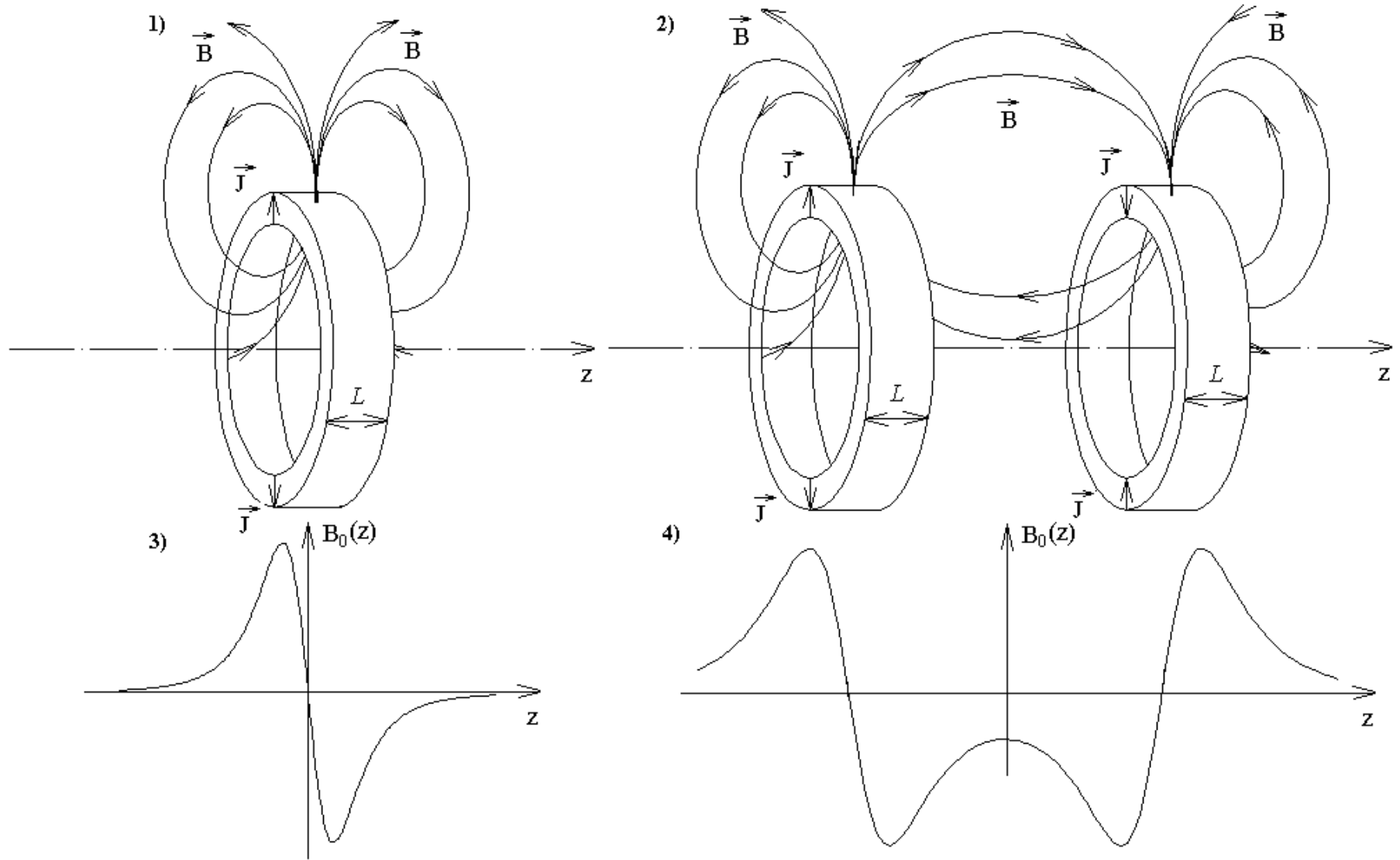

Beam dynamics in the gun without any magnetic fields

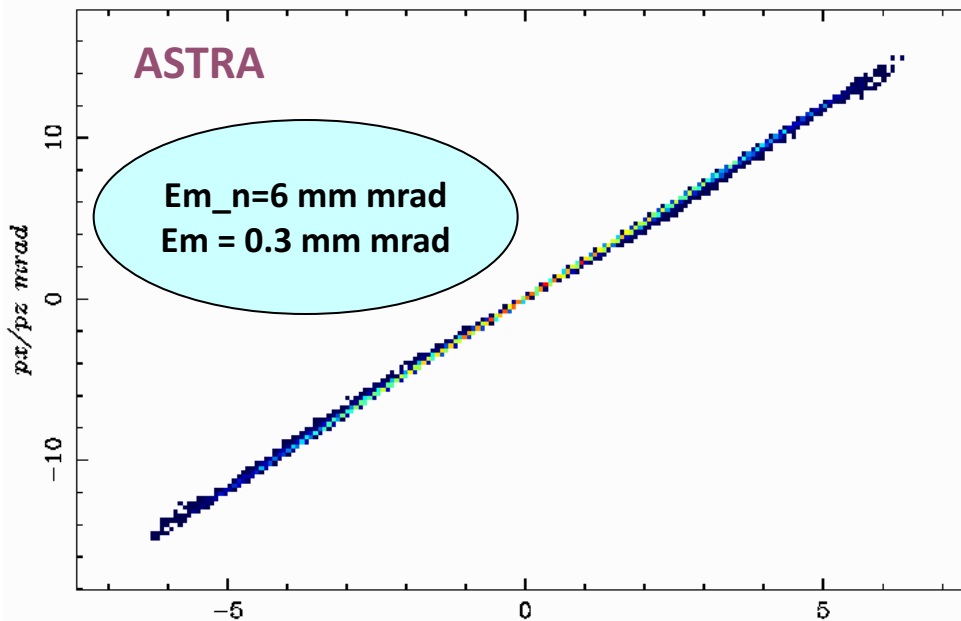
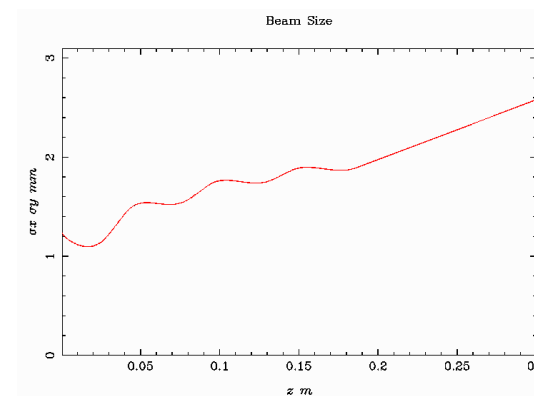
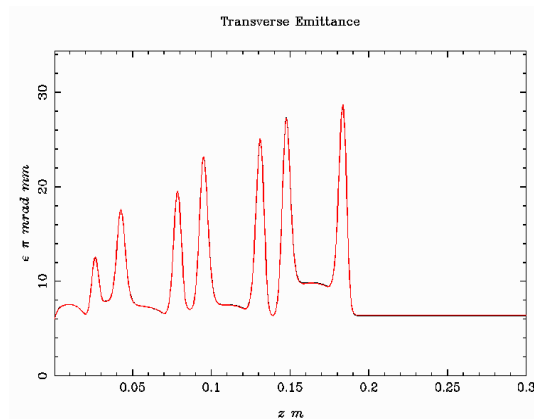
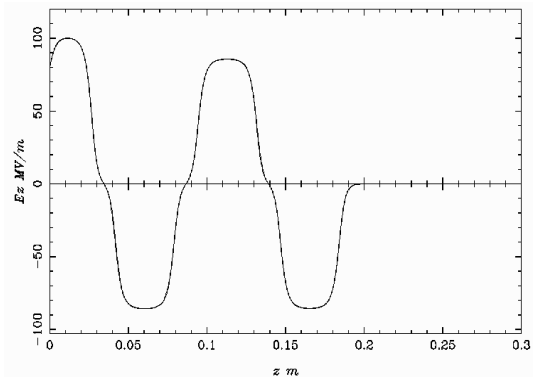

53784 particles @ 0.710028 ns

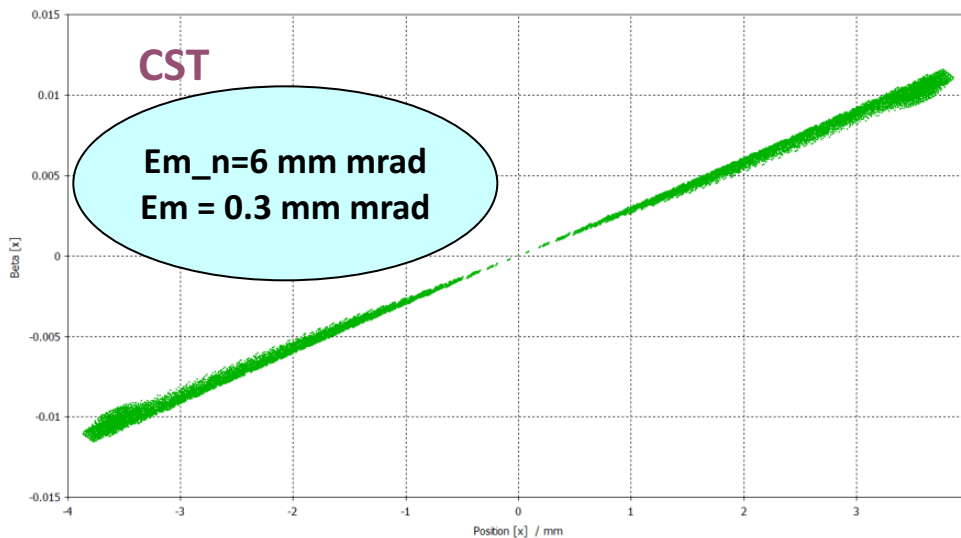

Two guns comparison

Parallel coupled accelerating structure

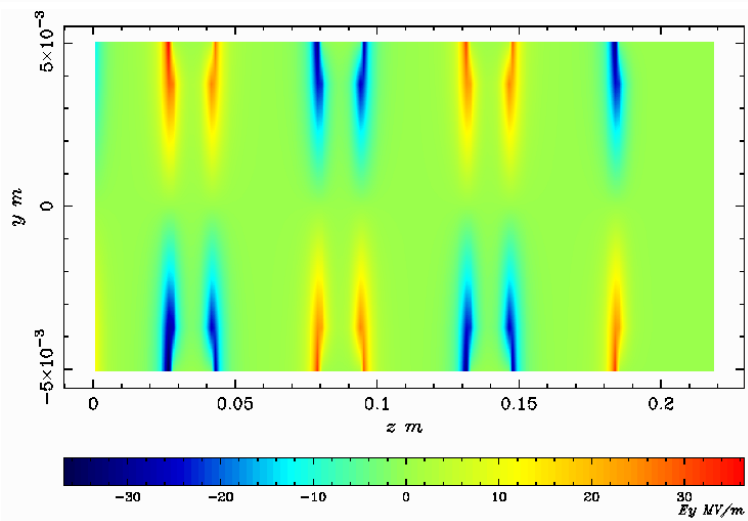
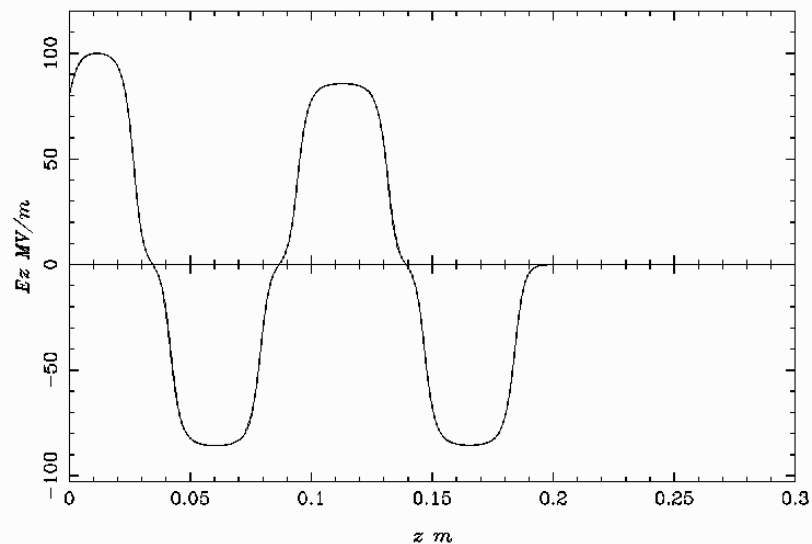
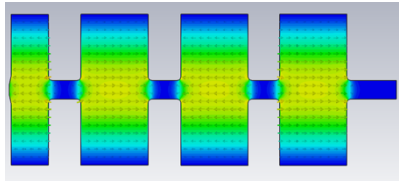

Ordinary accelerating structure

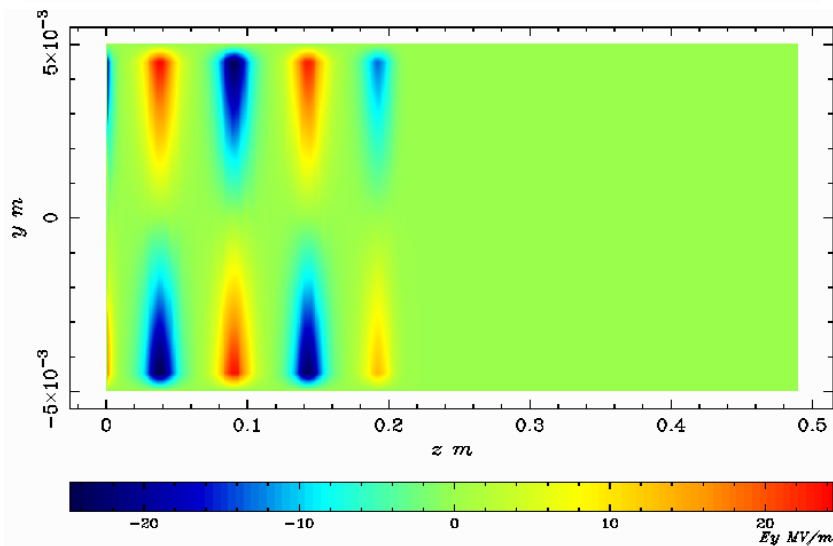
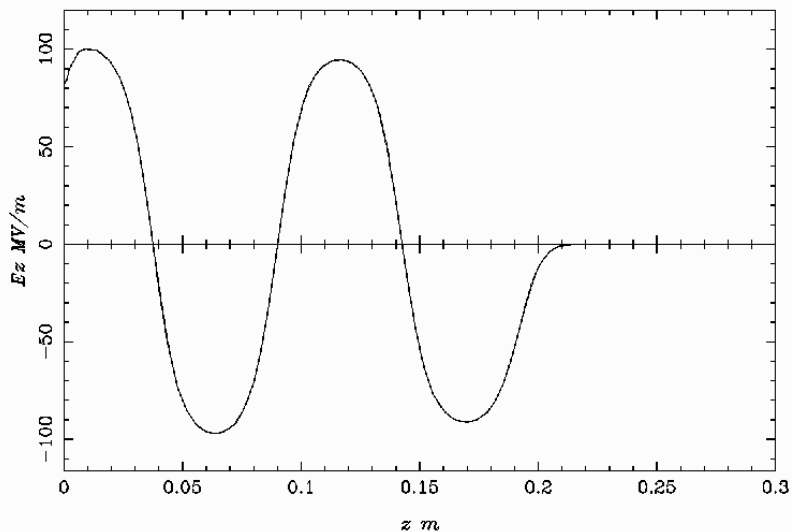
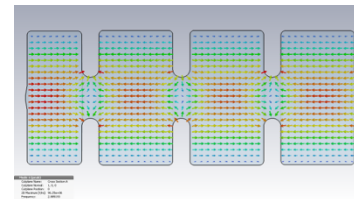

Emittance growth in combined solenoid-cavity section

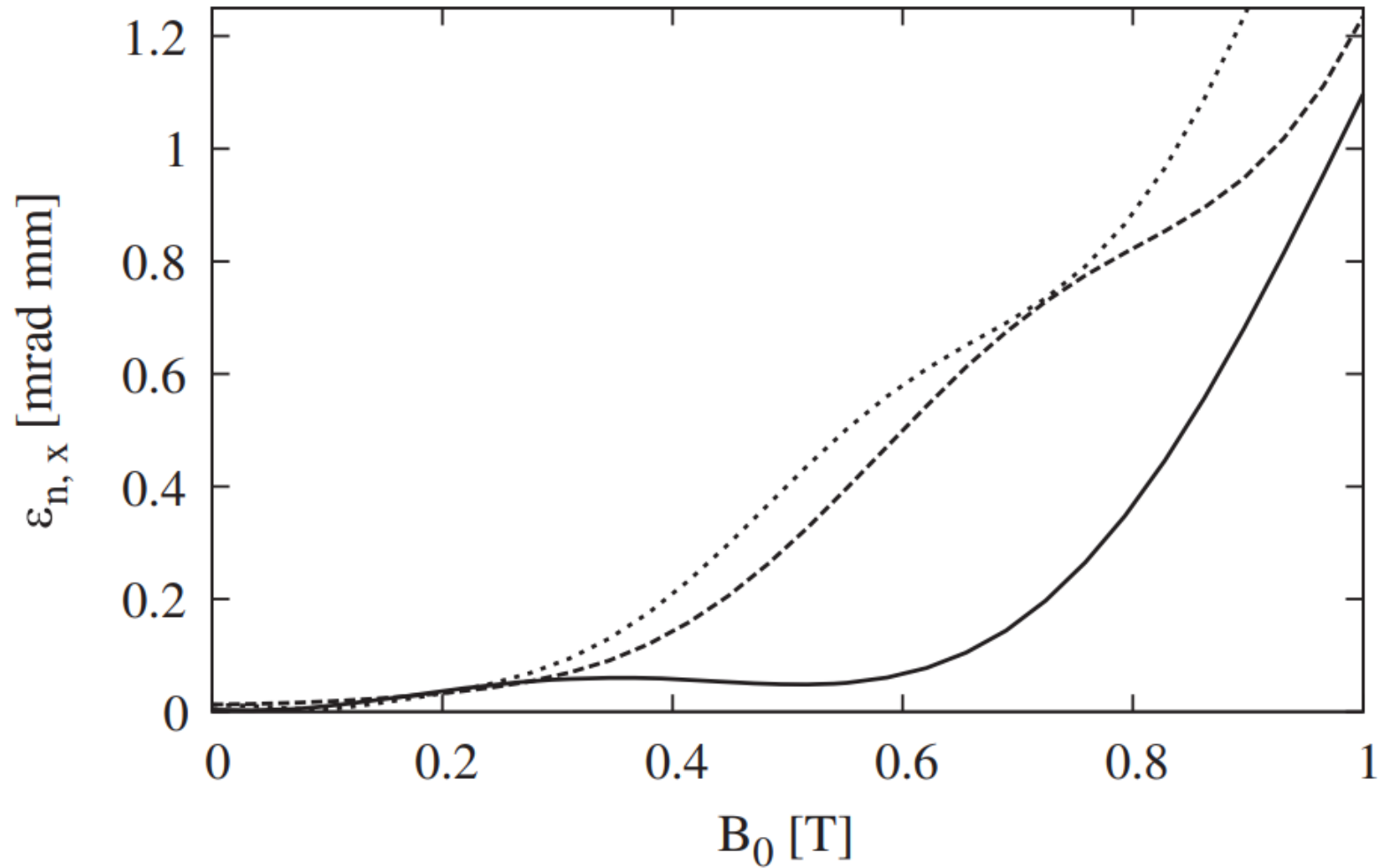

SLAC Estimation of the electric field distribution for Gaussian beam

