ACCELERATOR PROJECTS AND DEVELOPMENT OF THE ACCELERATOR TECHNOLOGY

Alexander Novokhatski
SLAC National Accelerator Laboratory

Accelerator seminar

KEK, February 2020

Thanks for invitation

- I'm so glad to visit KEK, the outstanding High Energy Physics laboratory and participate in the accelerator study of the fantastic SUPER KEKB machine.
- Many thanks for invitation. I will be very happy to help.
- In this presentation I will talk about the accelerator projects, I was lucky to be involved in and about the development of the accelerator technology for future projects.
- Linear Colliders, B-factories, X-ray FELs and Future Circular Colliders

Some history

- In the middle of 70s the director of BINP **Andrei Mikhailovich Budker** organized a small group of researchers under the leadership of Vladimir Balakin to study a new type of an accelerator for colliding beams. He called this machine a “SuperLinac”, what we now call “Linear Colliders”
- The main task of the study was
 - To demonstrate a possibility to achieve a high gradient of acceleration of 1 MV/cm
 - And to solve all beam dynamics problems
- It is interesting that we managed to solve main problems.
- We developed a technology of fabricating high gradient accelerating structure. We managed to achieve almost 2 MV/cm in a cavity.
- We understood main beam dynamics problems and found solutions for almost all of them

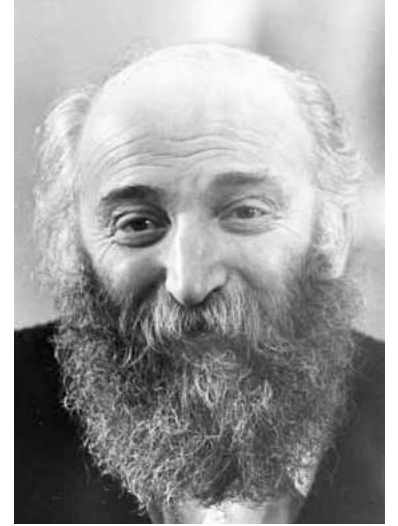

VLEPP Linear Collider

Unfortunately, Andrei Mikhailovich died in 1977 just before he became a sixty. A new director Alexander Nikolayevich Skrinsky continued the activity on Linear Colliders.

The project of the BINP Linear Collider (VLEPP) was first presented in 1978 at the International Symposium devoted A. M. Budker and All-union particle accelerator Conference in Dubna.

The results, published in Russian were translated to English at SLAC.

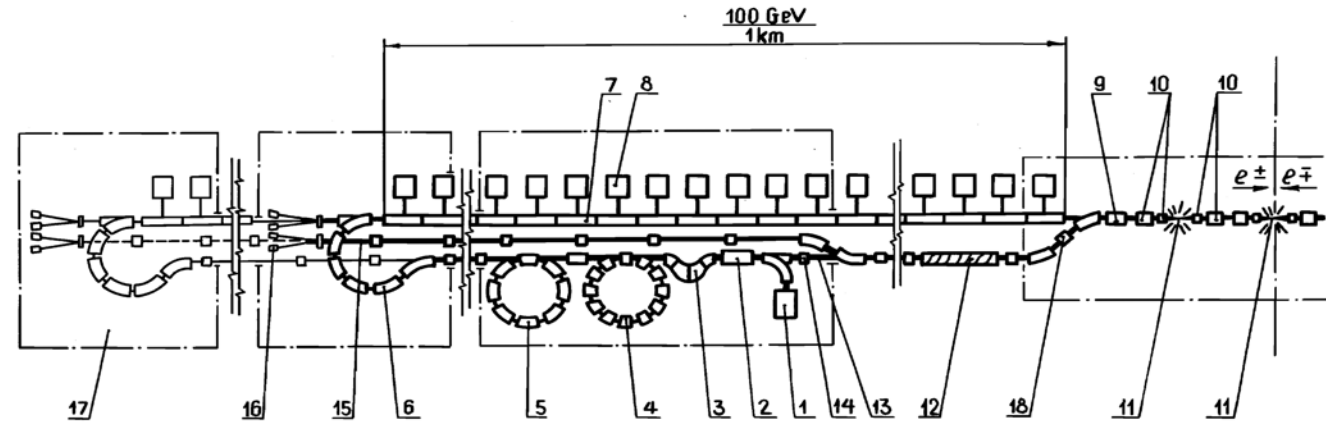
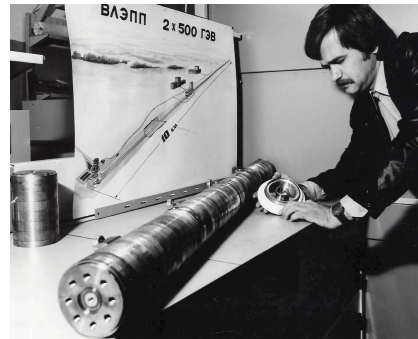

Fig.1

- | | | |
|-----------------------------|---|----------------------------------|
| 1. INITIAL INJECTOR | 6. BUNCHER | 11. COLLISION POINTS |
| 2. INTERMEDIATE ACCELERATOR | 7. ACCELERATING SECTIONS | 12. HELICAL ONDULATOR |
| 3. DEBUNCHER | 8. SHF SOURCE | 13. THE BEAM OF γ -QUANTA |
| 4. STORAGE RING | 9. PULSE DEFLECTOR | 14. CONVERSION TARGET |
| 5. COOLER -INJECTOR | 10. FOCUSING LENSES | 15. RESIDUAL ELECTRON BEAM |
| | 16. ELECTRON (POSITRON) BEAM EXPERIMENTS WITH STATIONARY TARGET | |
| | 17. THE SECOND STEP | |
| | 18. SPECTROMETER | |



Single bunch instability and BNS damping

- One of the main beam dynamics problems was a beam break-up effect, which limited the acceleration of the very high intense beams, needed to achieve high luminosity.
- To understand the structure of force acting in a bunch, we developed a numerical method to calculate electromagnetic interaction of the beam and accelerating structure.
- With a very good description of these forces we started doing beam dynamics simulation and immediately found a very strong transverse instability of a single bunch.
- Careful analyses of the beam dynamics showed the resonant structure of the instability.
- This important feature was the most impotent point in invention of a new method to damp the transverse instability, which later got the name “BNS Damping” by the first letters of the inventors Balakin, Novokhatski and Smirnov.

Physics of BNS damping. Shortly.

- The bunch head particles do not experience any action of the wake field and freely oscillate in the focusing lattice at the betatron frequencies.
- However these oscillations produce a periodical force for the particles of the bunch tail, which experience the action of the wake field.
- As the frequency of the force and the frequency of free oscillations are the same then the amplitude of oscillations of the tail's particles grow in time because of this resonance.
- An immediate solution for this situation is to destroy the resonance, that means to give different betatron frequencies to the particles of the bunch head and particles of the bunch tail.
- It can be done in many different ways, but a simple solution is to utilize the fact that a betatron oscillation frequency depends on a particle energy

Physics of the BNS damping

- Since the transverse wake field introduces defocusing the chromatic focusing can be used for compensation.
- By accelerating a bunch behind the crest of the accelerating field, the tail particles gain less energy than the head. Therefore, the tail particles are focused more by the quadrupoles than the head.
- The longitudinal wake field actually helps to increase the energy spread. The tail particles loss more energy due to the action of this field.
- With increasing of the particle energy during the acceleration, the energy difference can be reduced. The beam break up effect becomes small $\sim \frac{\gamma_0}{\gamma}$ and the bunch is now moved ahead of the crest to reduce the energy spread in the beam.

BNS damping works very well against a very strong instability

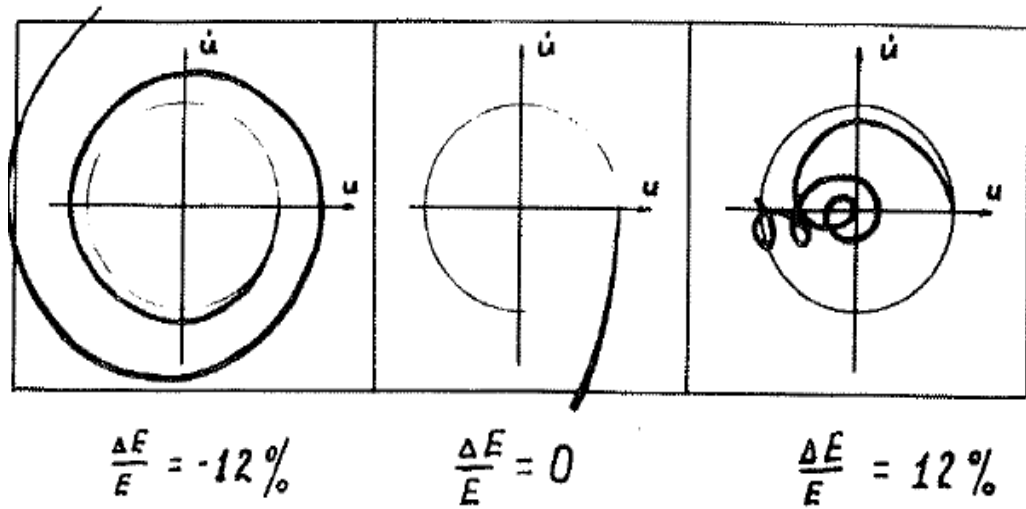

X' X phase plot for different energy spreads.

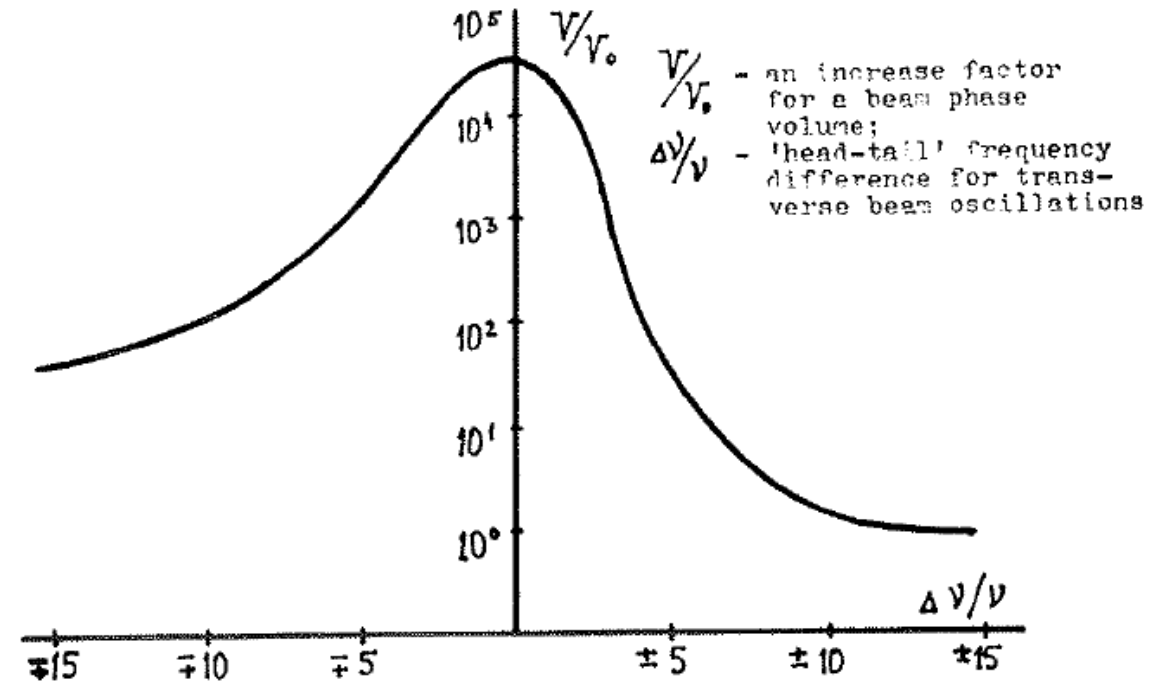

Relative emittance at the exit of the 100 GeV accelerator section versus the initial energy spread. With the initial energy spread of 12% the beam can reach at the section exit with a minimally achievable spread of 3%

Comparison BNS and Landau damping

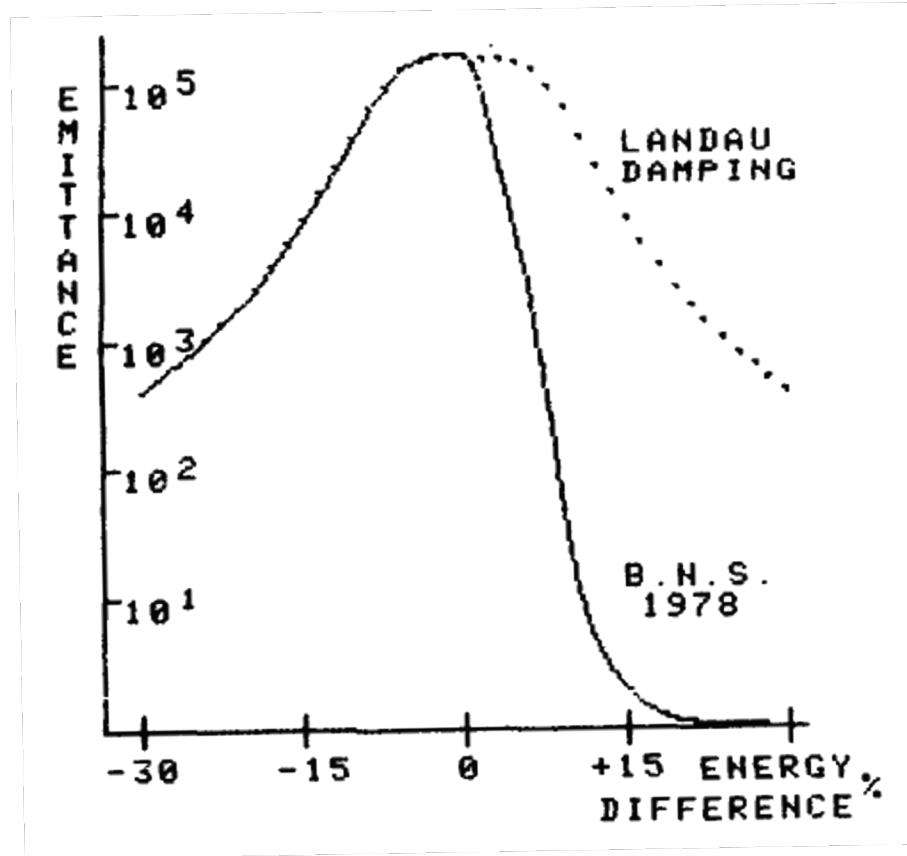

Landau damping works something like BNS damping but with an opposite sign of the energy spread and cannot damp instability completely

Landau damping (stochastic energy spread) less effective than BNS damping.

Application

- BNS damping was proposed to use in different Linear Collider project
- BNS damping helped to increase luminosity of the SLAC Linear Collider many times.
- BNS damping was effectively used during the operation of the SLAC PEP-II B-factory for intense injecting beams.
- Naturally, it can work in the multi-bunch regime as well.

Injector for electron-positron colliders at BINP

Experience with VLEPP project helped to design an electron-positron injector for circular colliders at BINP. It started operation several years ago (P. Logachev).

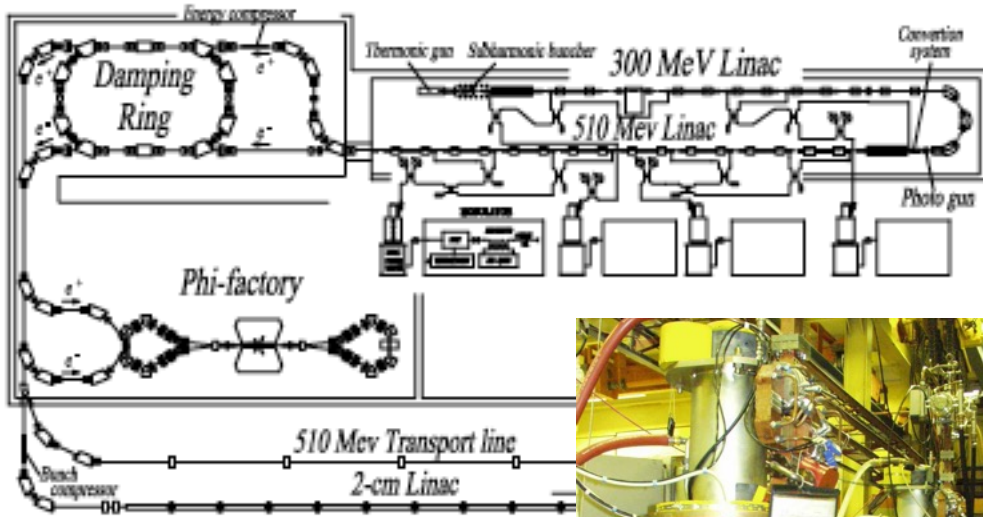

SLAC klystrons are used for electron and positron linacs.

TESLA Linear Collider

- The TESLA Linear Collider project at DESY had also FEL, mainly to support the Collider. However there was a concern about the possibility of the accelerating of a short bunch in the superconducting accelerator structure. Some accelerator theories predicted that electromagnetic field of a short bunch, which contains frequencies above 750 GHz can destroy the Cooper pairs and, in this way, quench the superconductivity
- The wake field code developed for VLEPP helped to understand this problem

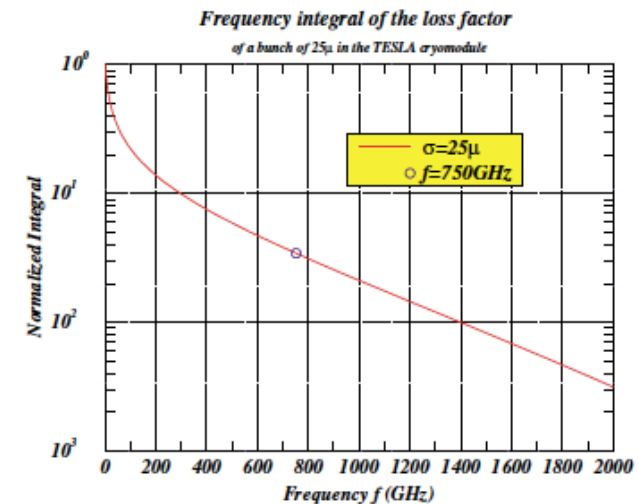
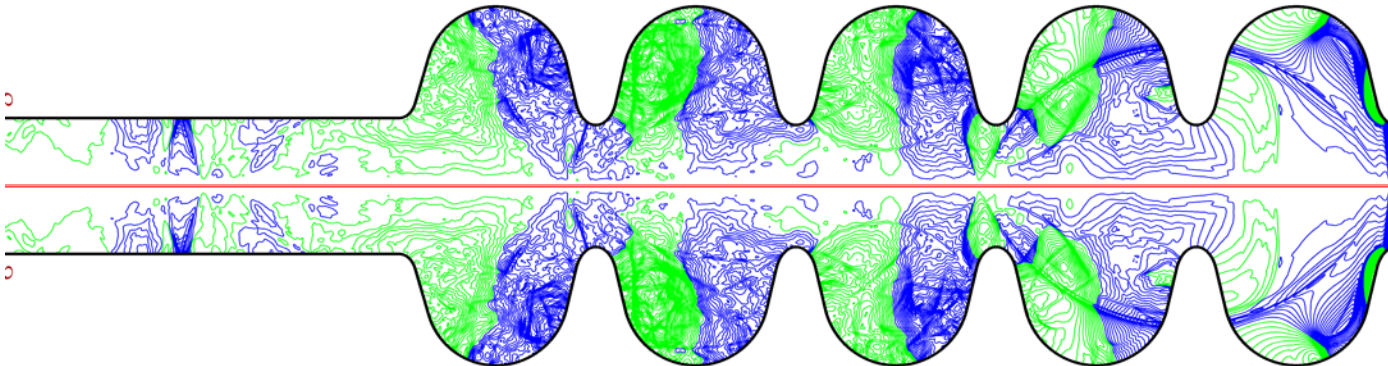

Figure 3: Fractal part of the loss factor above a lower frequency boundary.

A. Novokhatski, Feb. 21, 2020

Fight against transverse wake fields in the PEP-II B-factory rings

- ❑ Transverse wake fields are generated in the asymmetrical parts of the beam pipe.
- ❑ Transverse wake fields can penetrate through the small hole in the vacuum chamber or longitudinal slots of shielded bellows, vacuum valves and RF shields.
- ❑ Transverse wake fields may propagate long distances.

Temperature raise in IR vertex bellows

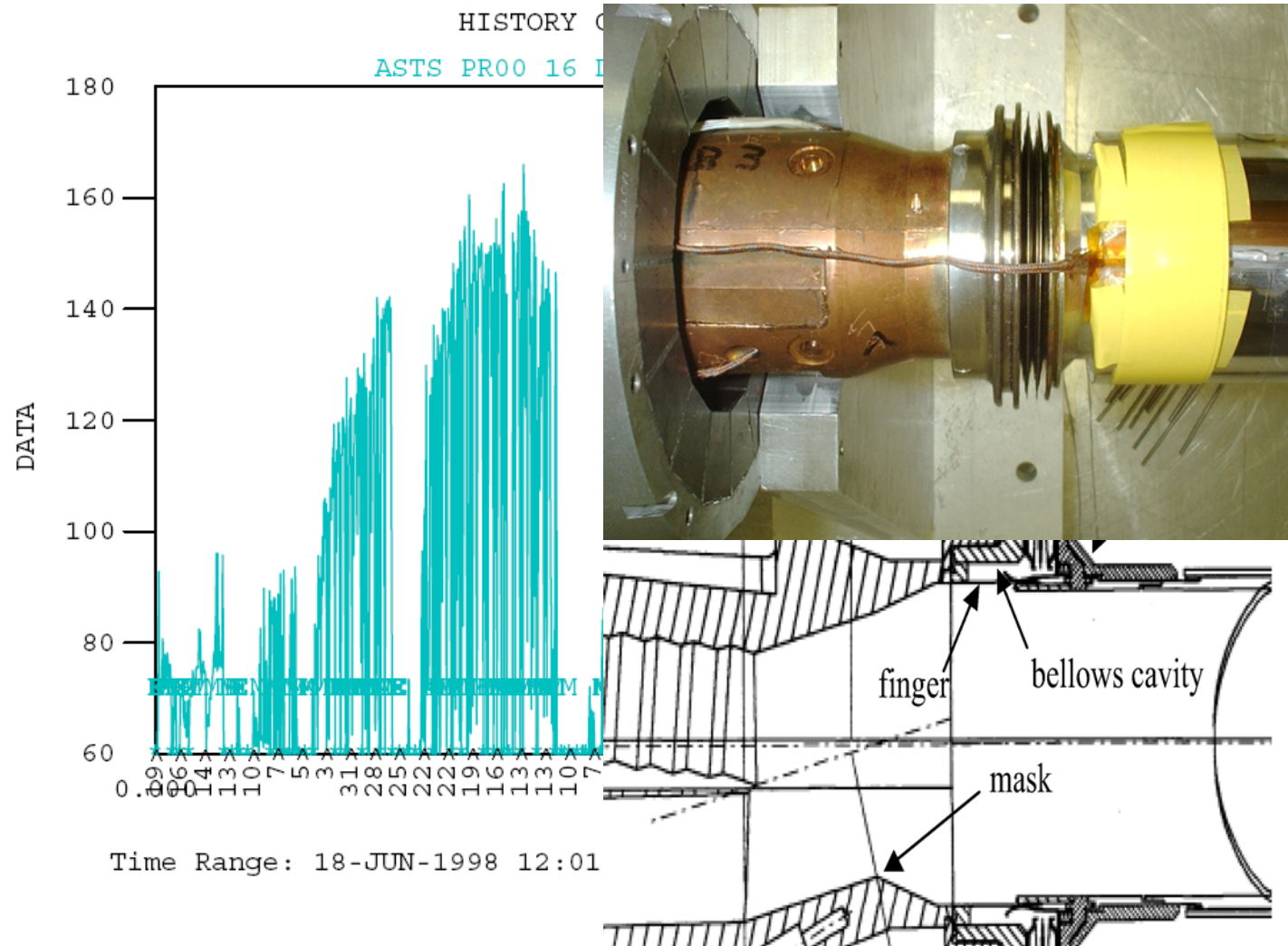

Temperature raise in shielded bellows

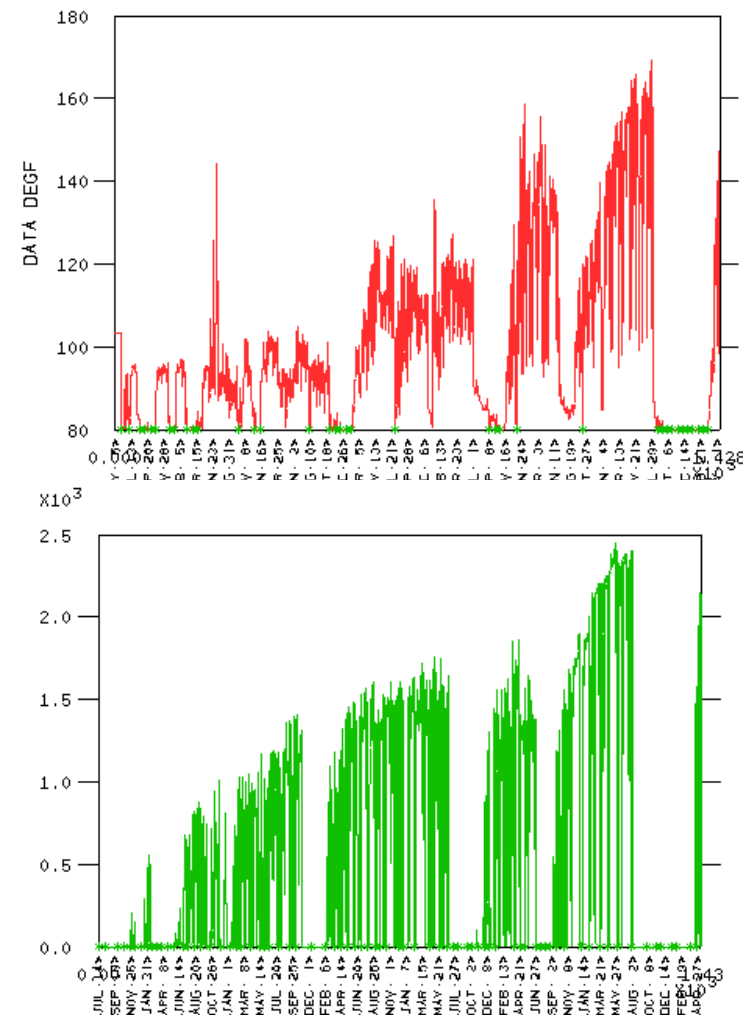
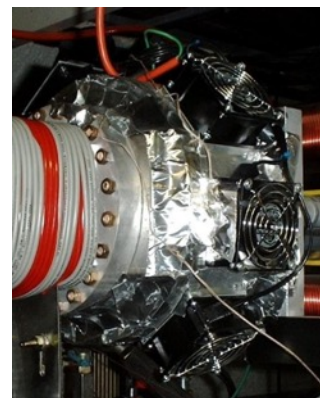
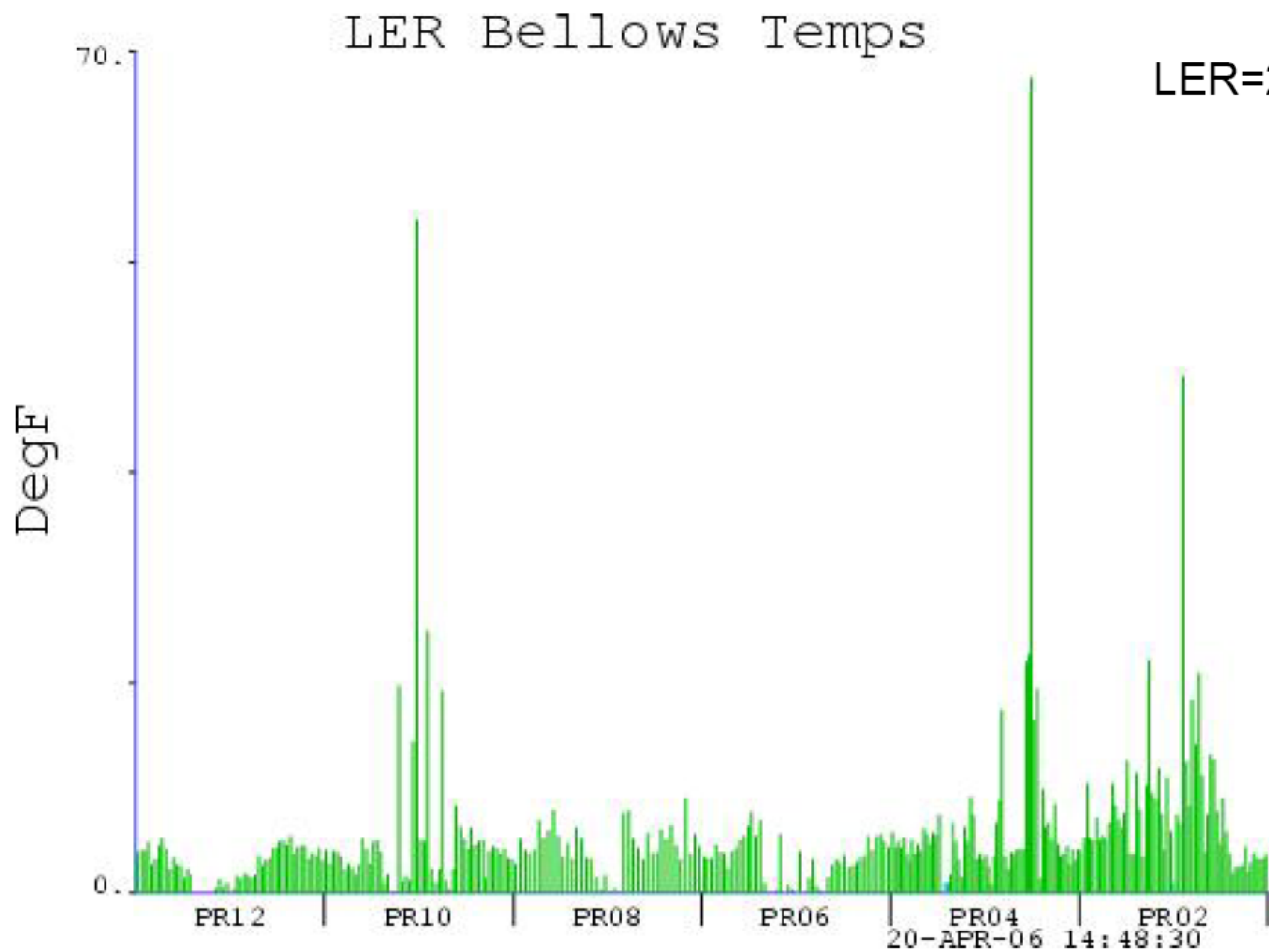

HOM leaking from TSP heater connector

The pumping section is 5.5 m long and consists of the beam chamber and an ante-chamber. Electromagnetic fields, excited in the beam chamber penetrate to the ante-chamber and then through the heater feed-through come out.

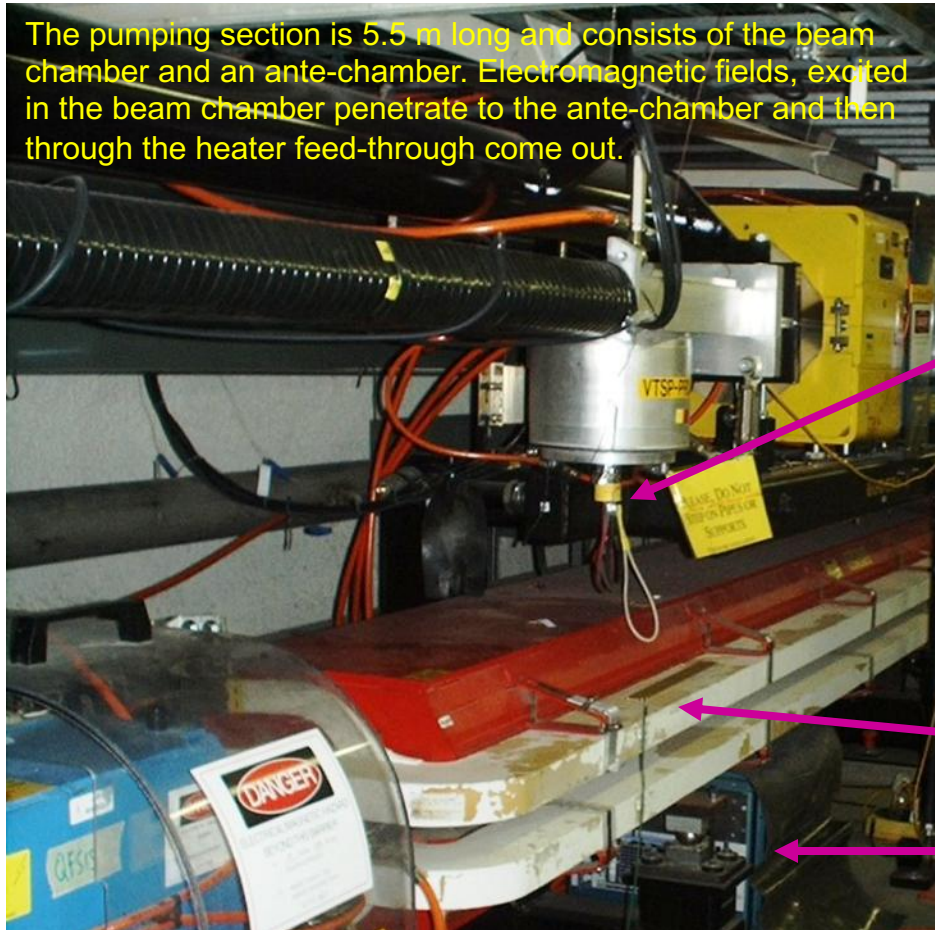

The power in the wake fields was high enough to char beyond use the feed-through for the titanium sublimation pump (TSP).



antenna

HOM spectrum from Spectrum analyzer

Water-Cooled Absorber in the First Arc Chamber

HOM power reached level of 1 kW

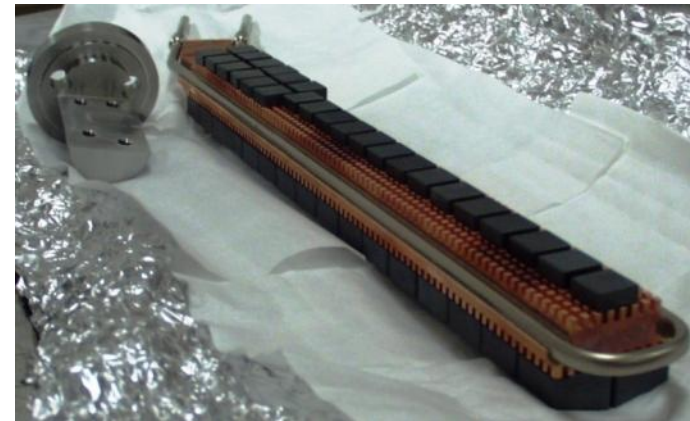
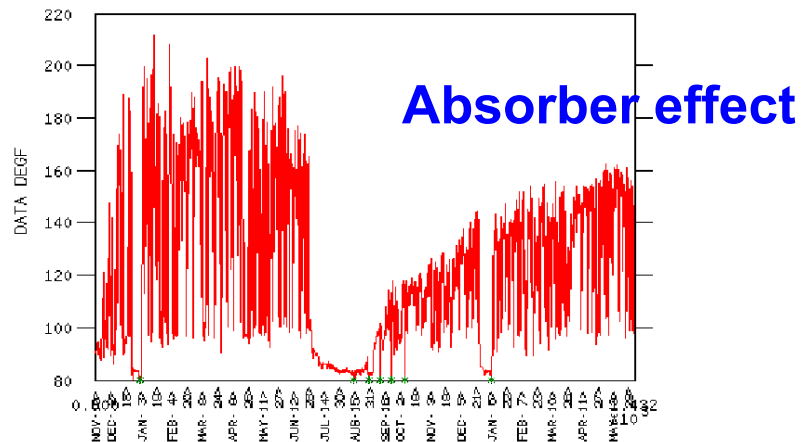
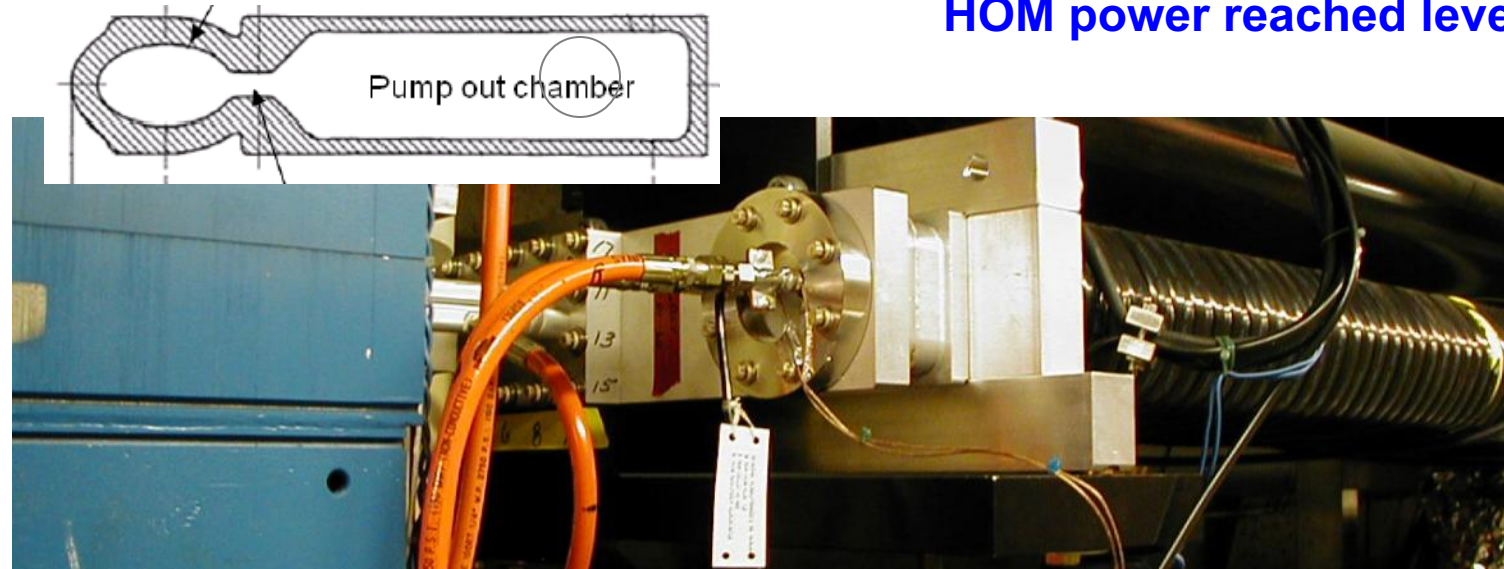

PEP-II collimators are the main source for transverse wave production

HOM power in bellows

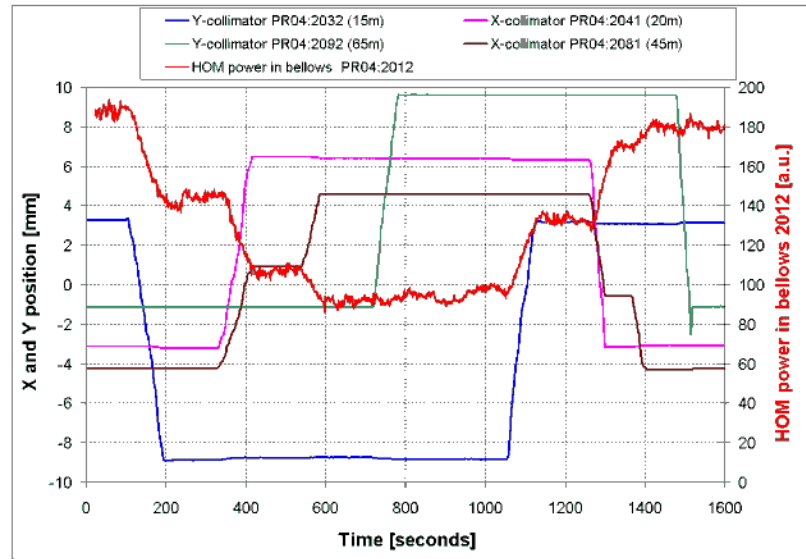

HOM power in absorber

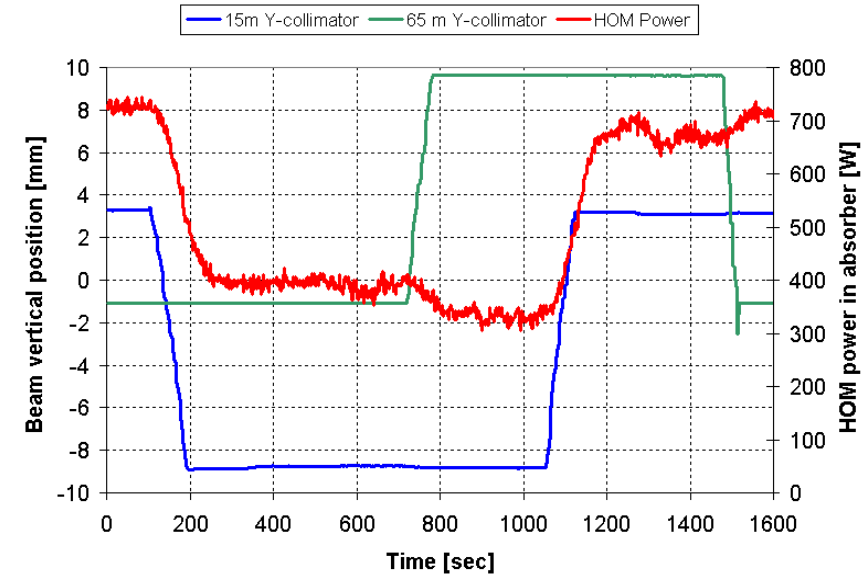

We found a strong correlation with the beam position near collimators which are far away from the bellows and arc chamber.

Dipole and quadrupole waves generating in collimators

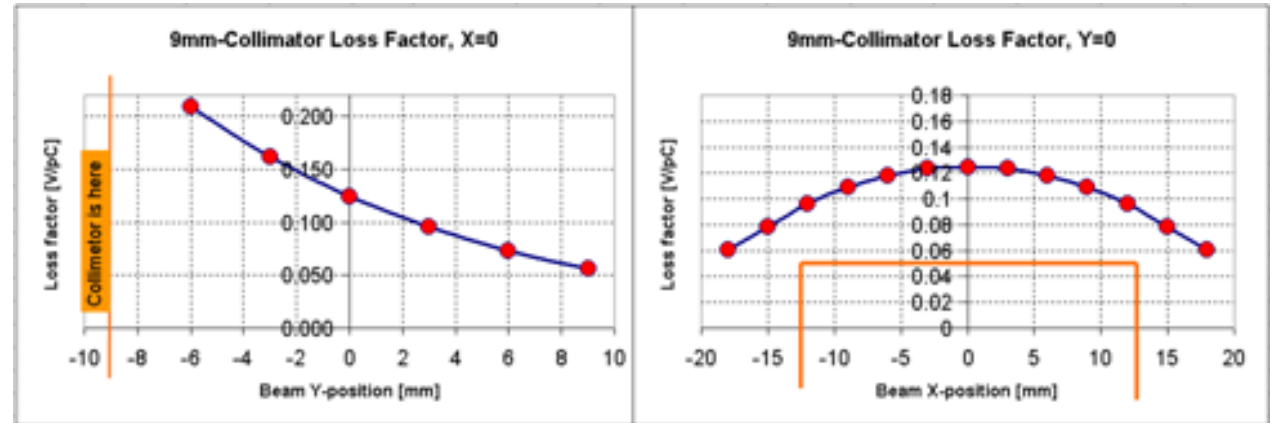
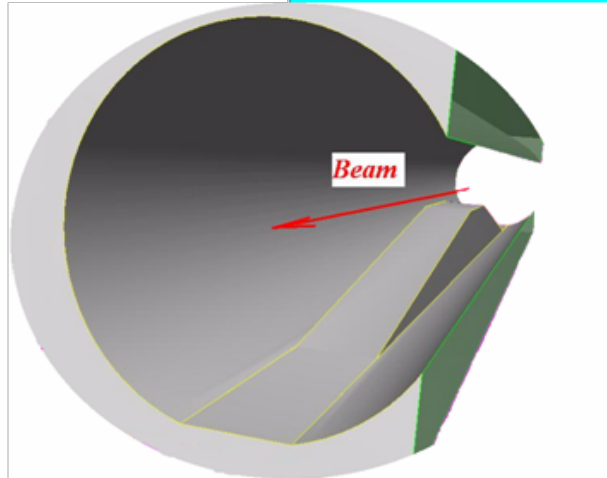
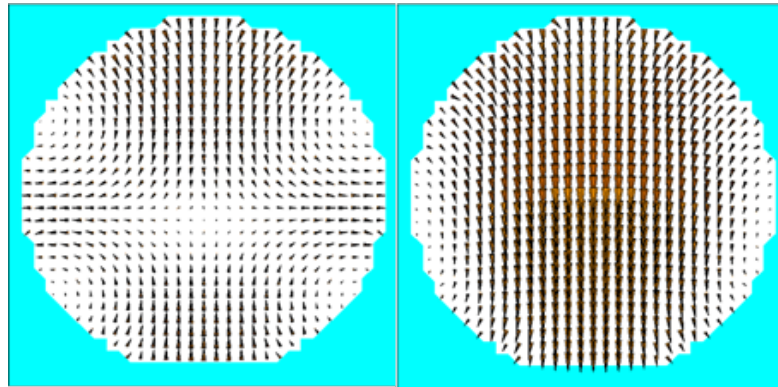

Transverse wake fields couple to valve cavities

- Shielded fingers of some vacuum valves were destroyed by breakdowns of intensive HOMs excited in the valve cavity.

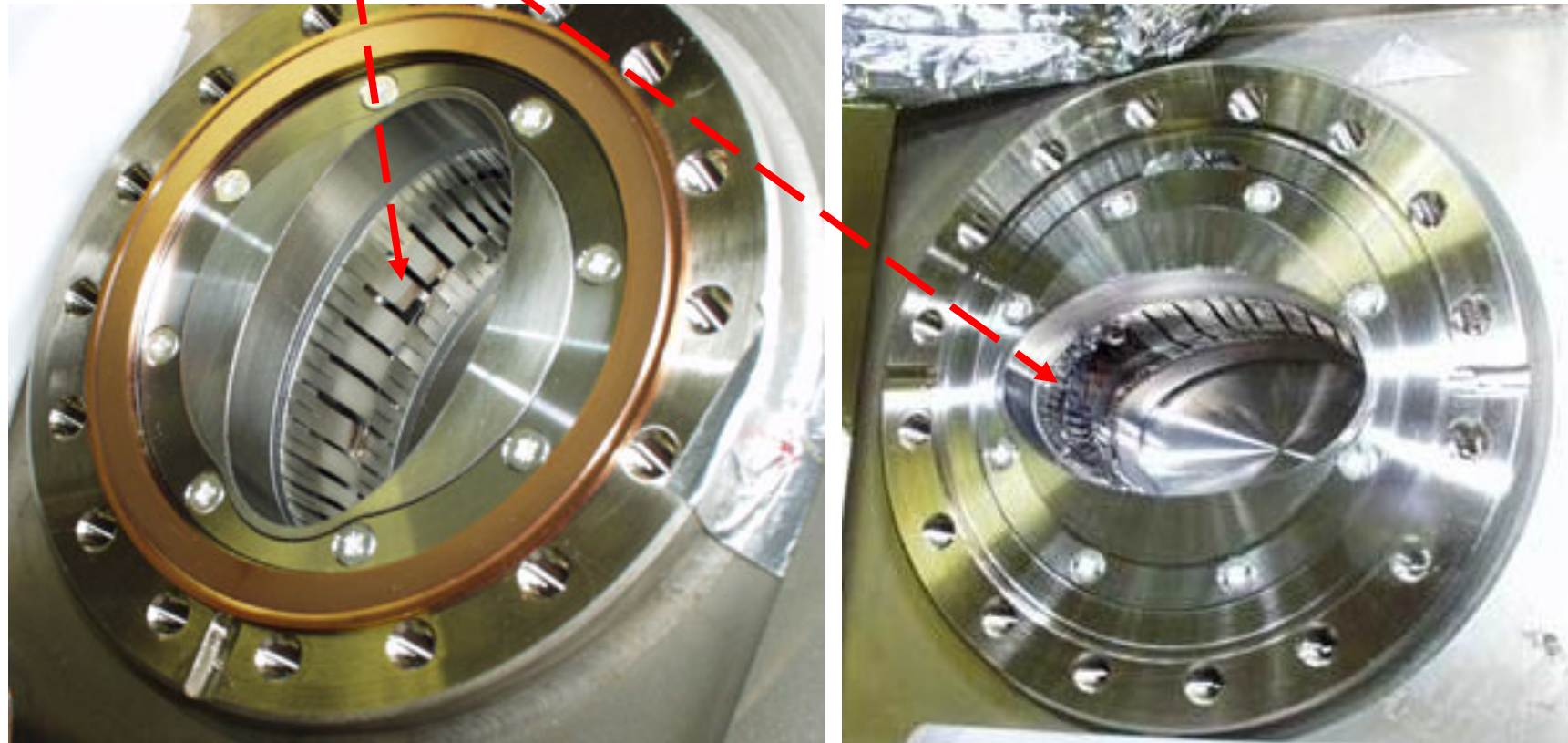

Straight bellows – HOM absorber design

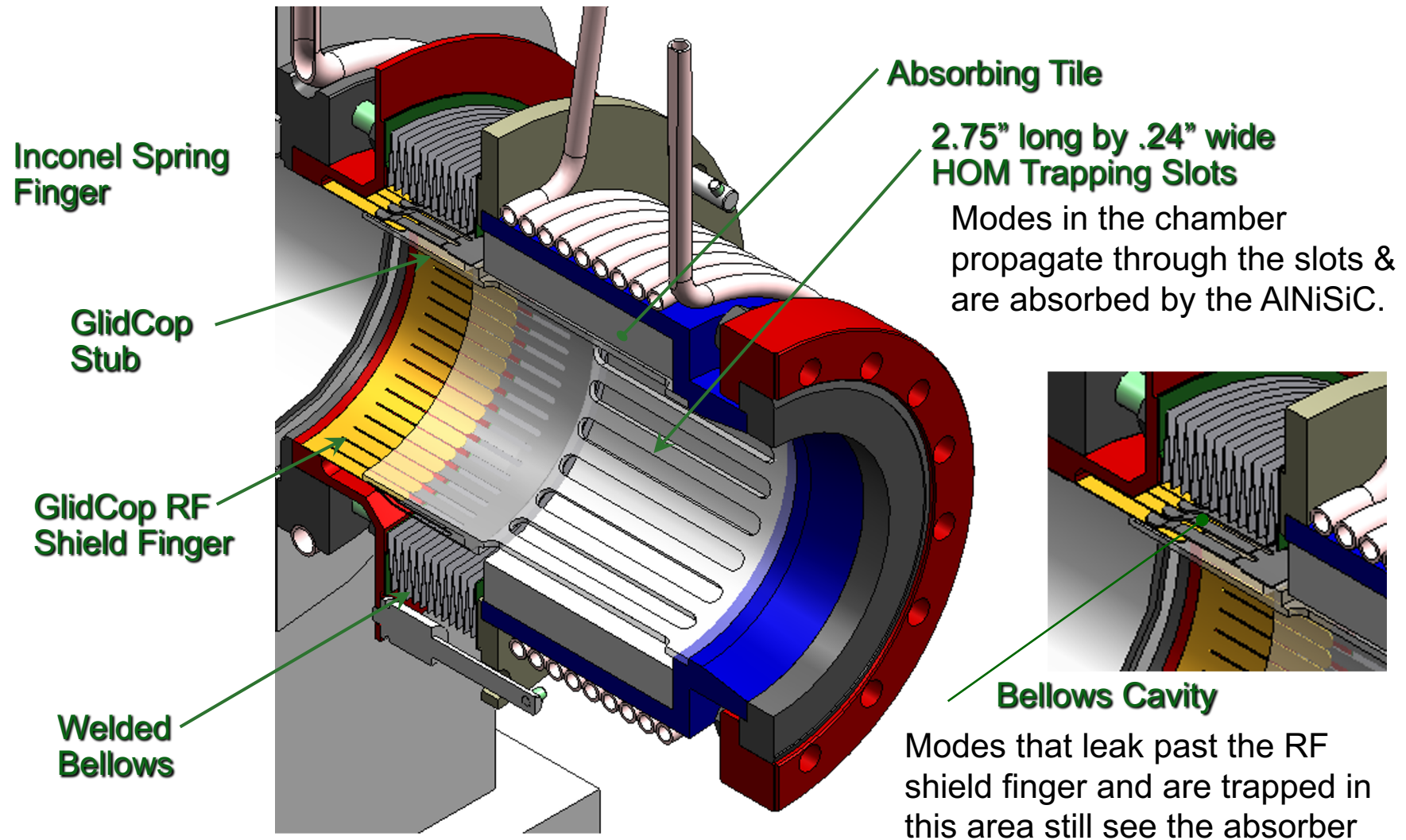

Technology and efficiency of the HOM absorber

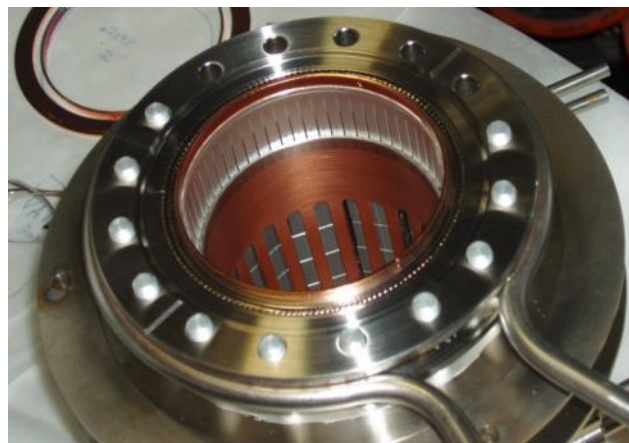
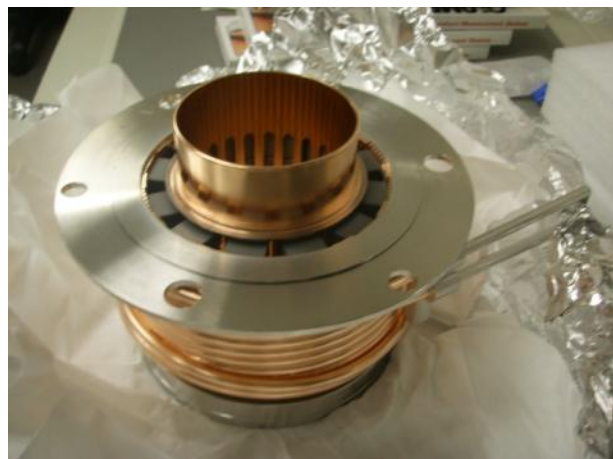
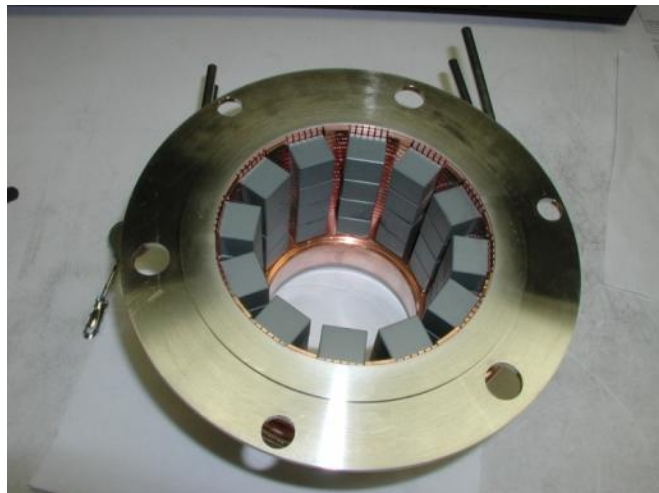

$$\eta = \frac{P_{before} - P_{after}}{P_{before}} \cdot 100\% = \frac{145 - 85}{145} \cdot 100\% = 41\%$$

Almost as it was designed!

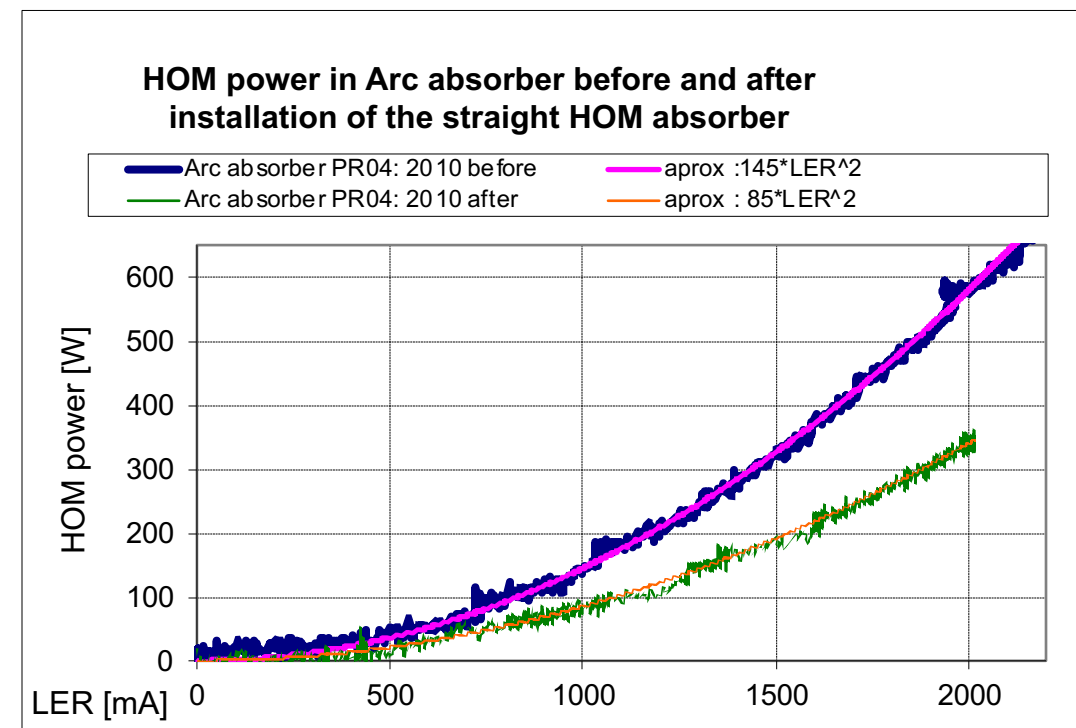

SLAC has developed high efficiency HOMs absorbers for different cross-sections and installed 25 in the rings

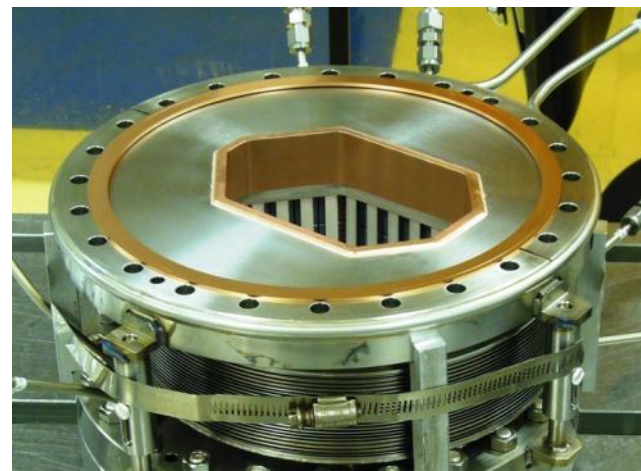
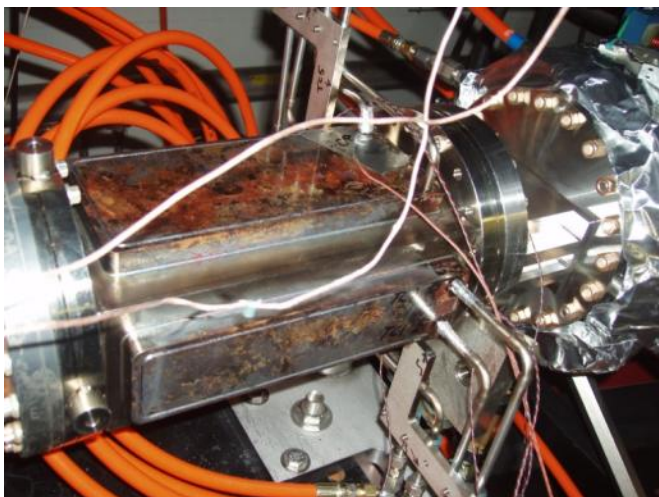
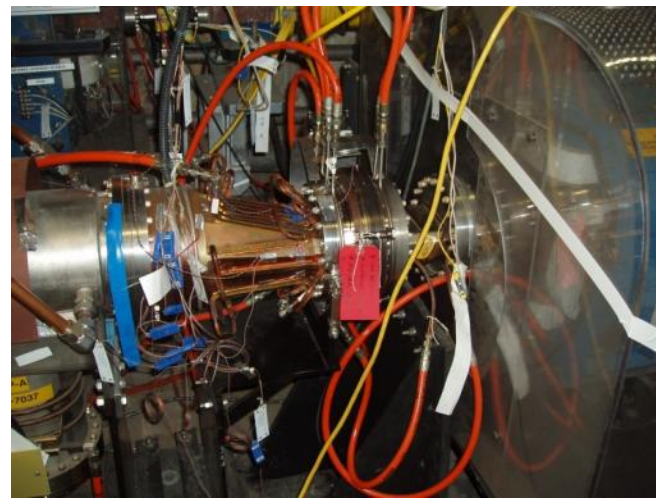
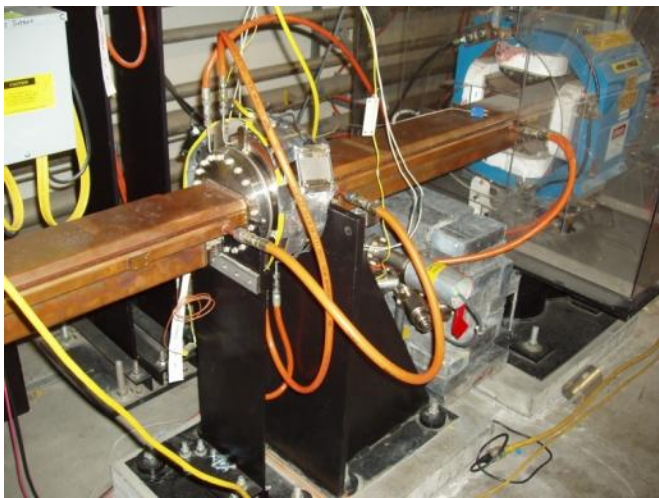

- *A. Novokhatski and S. Weathersby*, “RF Modes in the PEP-II Shielded Vertex Bellows”, Proceedings of the PAC’2003, Portland, p.2981.
- *A. Novokhatski, J. Seeman, M. Sullivan*, “RF Heating and Temperature Oscillations due to a small Gap in a PEP-II vacuum Chamber, PAC 2003
- *A. Novokhatski, S. DeBarger, F.-J. Decker, A. Kulikov, J. Langton, M. Petree, J. Seeman, M. Sullivan*, "Damping the higher order modes in the pumping chamber of the PEP-II low energy ring", EPAC 2004, Lucerne, Switzerland, 2004; SLAC-PUB-10531, 2004.
- *S. Weathersby, M. Kosovsky, N. Kurita, A. Novokhatski, J. Seeman*, “A Proposal for a New HOM Absorber in a Straight Section of the PEP-II Low Energy Ring”, PAC’05, p.2173.
- *A. Novokhatski*, “HOM Effects in Vacuum Chamber with short bunches”, PAC 2005.
- *A. Novokhatski, J. Seeman and S. Weathersby*, “High efficiency absorber for damping transverse fields” Phys. Rev. ST Accel. Beams **10**, 042003 (2007).
- *A. Novokhatski, J. Seeman and M. Sullivan*, Modeling of the Sparks in Q2-bellows of the PEP-II SLAC B-Factory, PAC 2007.
- *A. Novokhatski, S. DeBarger, S. Ecklund, N. Kurita, J. Seeman, M. Sullivan, S. Weathersby, U. Wienands*, “A New Q2-Bellows Absorber for the PEP-II SLAC B-Factory”, PAC 2007
- *A. Novokhatski, J. Seeman, M. Sullivan, U. Wienands*, “Analysis of the Wake Field Effects in the PEP-II SLAC B-factory”, PAC 2009

LCLS. SLAC LINAC collimator and THz radiation may come out

Gap 2 x 1.6 mm

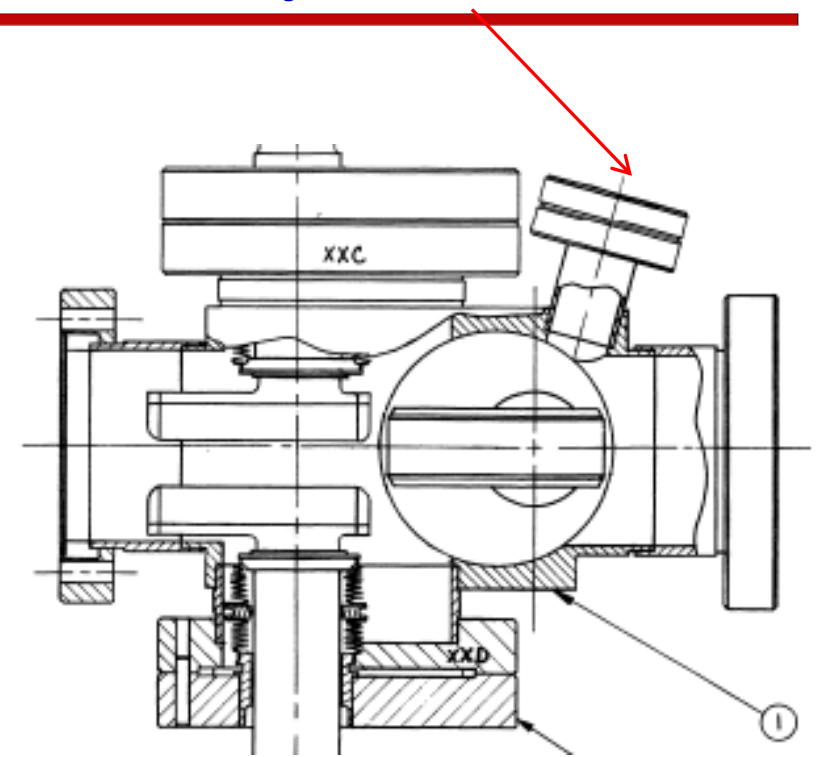
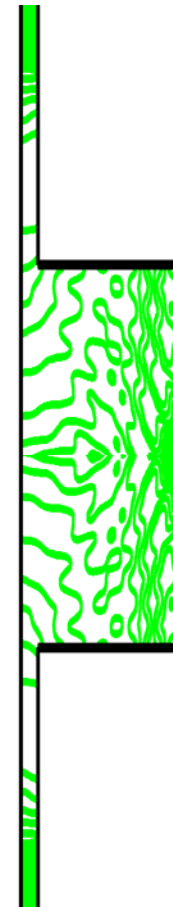
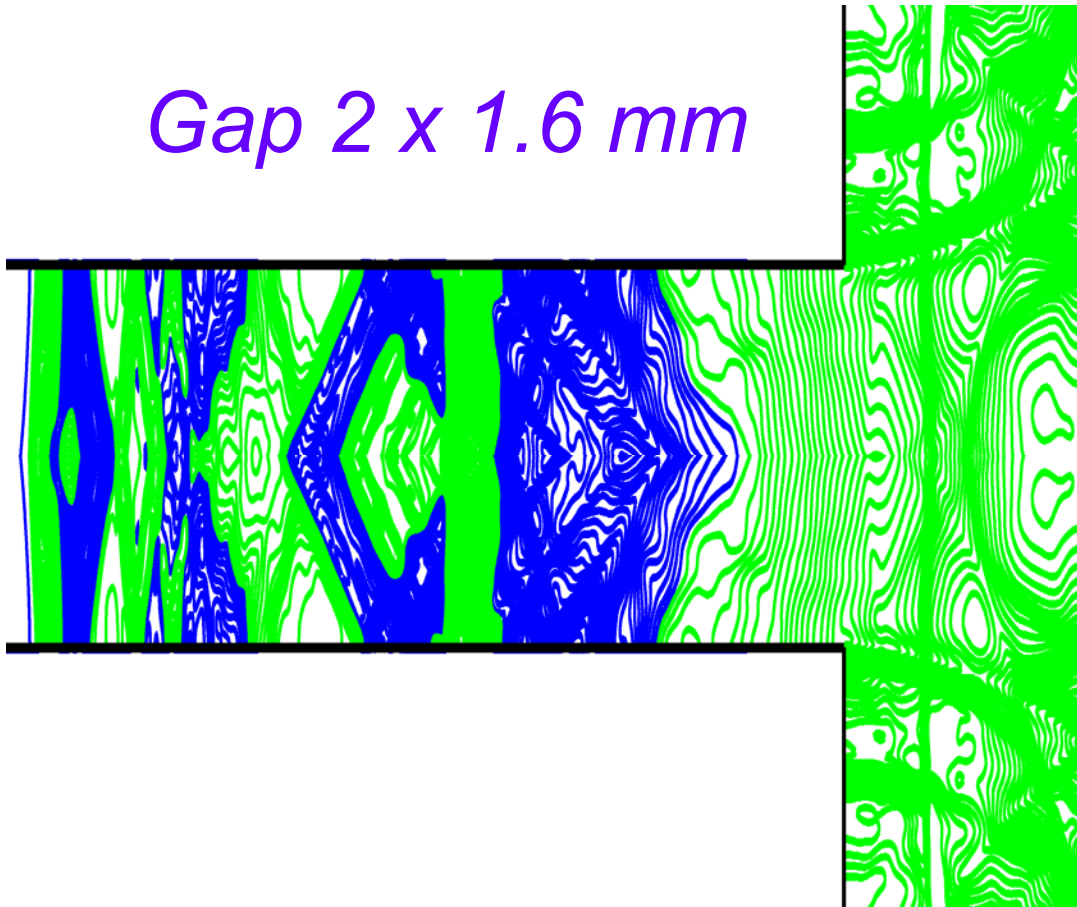

Vertical beam position (kick) and relative bunch charge vs a collimator bottom jaw position (measurement)

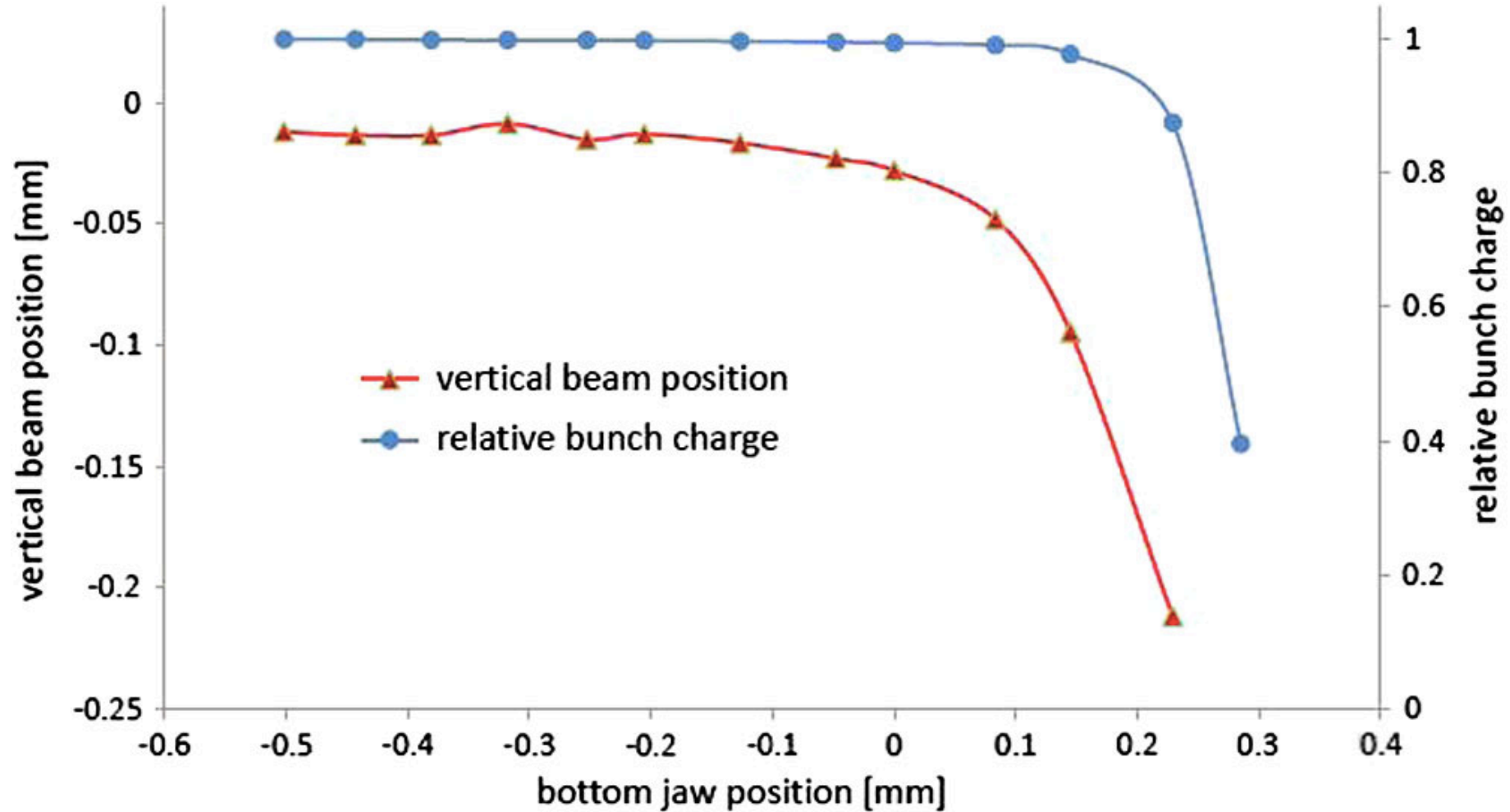

FEL pulse energy, beam emittance and relative bunch charge vs the collimator jaw position (measurement)

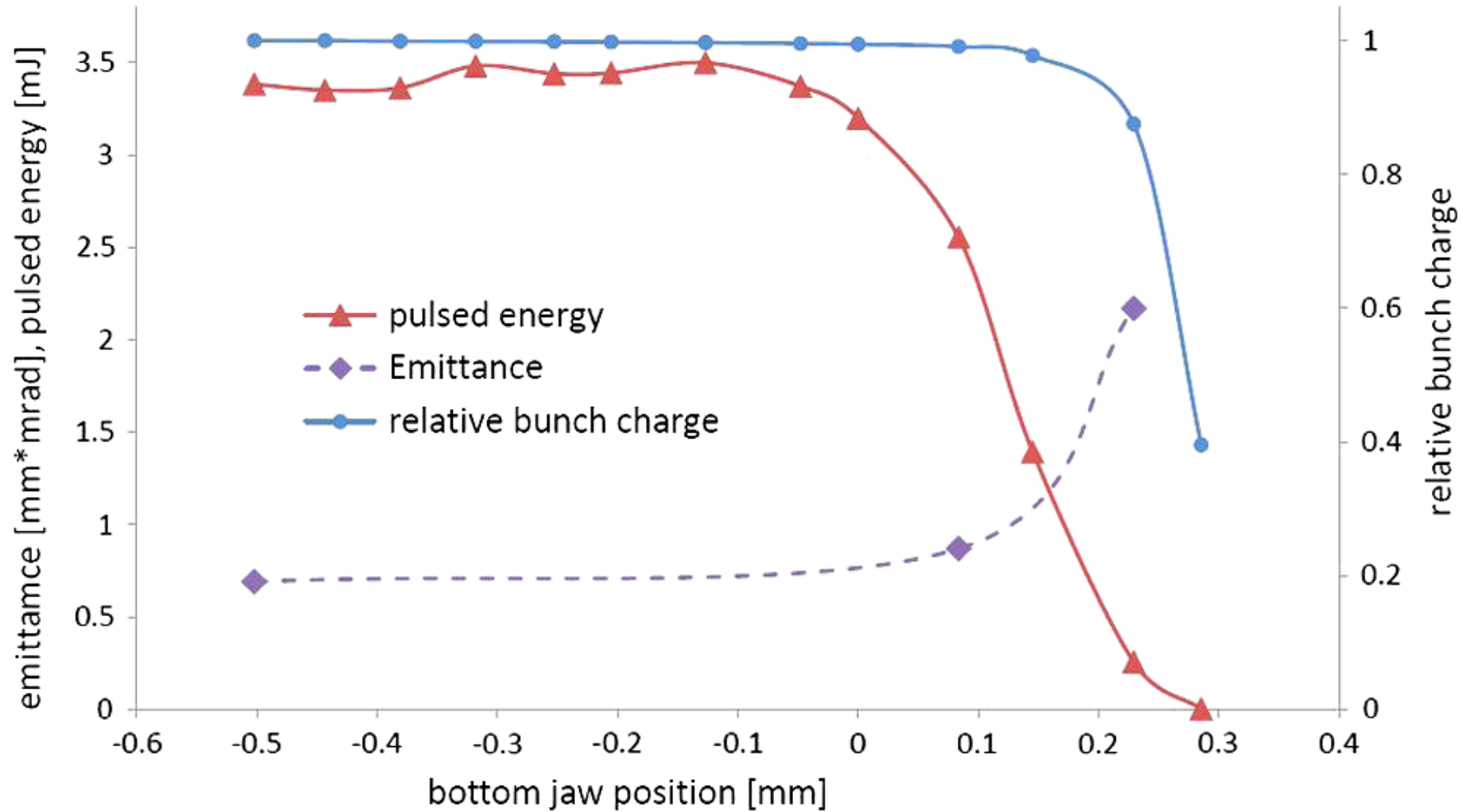

LCLS horizontal and vertical “dechirpers”

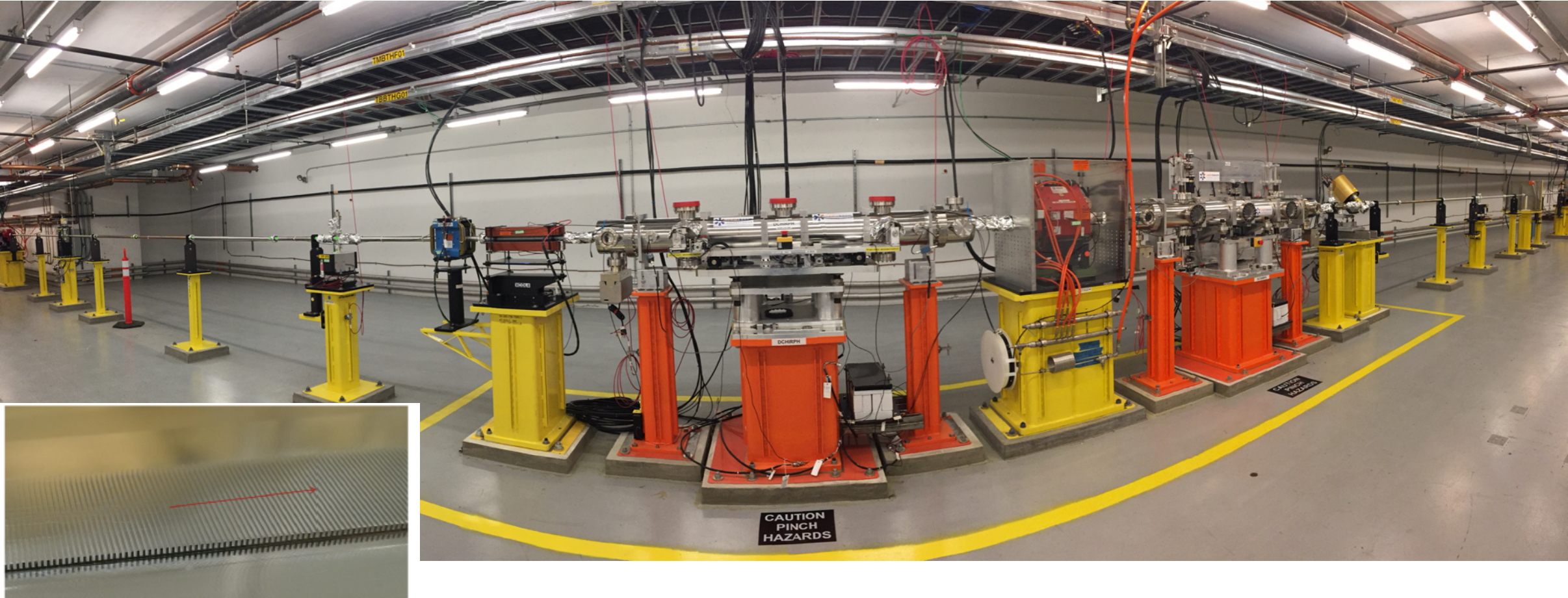

Originally, we plan to measure the beam profile, but ...

Proceedings of IPAC2016, Busan, Korea

MOPOW046

RADIABEAM/SLAC DECHIRPER AS A PASSIVE DEFLECTOR*

A. Novokhatski[†], A. Brachmann, M. Dal Forno, V. Dolgashev, A. S. Fisher, M. Guetg, Z. Huang, R. Iverson, P. Krejcik, A. Lutman, T. Maxwell, SLAC, Menlo Park, California, USA
J. Zemella, DESY, Hamburg, Germany

Abstract

We discuss the possibility of using the Radia-Beam/SLAC dechirper recently installed at LCLS for measuring the length of very short bunches, less than 1 fs and perhaps as short as 100 as. When a bunch travels close to one of the jaws, each particle gets a transverse kick depending on its position in the bunch. The tail particles get more kick. The transverse force also depends nonlinearly on the transverse position. The stretched bunch has been measured at the YAG screen 100 m downstream of the dechirper. The most important aspect of this measurement is that no synchronization is needed. The Green's function for the transverse kick was evaluated based on precise wake field calculations for the dechirper's corrugated structure. Using this function, we can recover the longitudinal shape of the bunch. This may also help to see if a bunch has any micro-bunch structure. Recent measurement using wire scanners showed that the kick from the dechirper can be strong enough to stretch a short bunch.

goal of this device is to remove energy chirp from a bunch, it is known as the "dechirper" [3].

WAKE FIELDS IN THE DECHIRPER

As previously proposed, a dechirper takes energy from the beam through the interaction of the bunch electromagnetic field with a metal corrugated structure. The practical design of the dechirper consists of two identical movable parallel plates (jaws) with corrugated walls in the form of a periodic set of planar ridges, as shown schematically in Fig. 1. The period is 0.5 mm; the thickness of a ridge is a half of a period. The transverse sizes of a ridge are: height $h=0.5$ mm, length $L_x = 12$ mm. Definitions of the sizes are given in Fig. 1. Both jaws can be moved independently to the center, with the gap g between jaws adjustable from 0.1 to 20 mm. Two dechirpers, each with a (longitudinal) length of 2 m, were installed. The vertical dechirper has horizontal jaw faces and moves vertically, as shown in Fig. 1; the horizontal dechirper has vertical jaw faces and moves horizontally.

Nuclear Inst. and Methods in Physics Research, A 921 (2019) 57–64

Contents lists available at ScienceDirect



Nuclear Inst. and Methods in Physics Research, A

journal homepage: www.elsevier.com/locate/nima

A simple method for a very short X-ray pulse production and attosecond diagnostic at LCLS

Alexander Novokhatski^{*}, Dorian Bohler, Axel Brachmann, William Colocho, Franz-Josef Decker, Alan S. Fisher, Marc Guetg, Richard Iverson, Patrick Krejcik, Jacek Krzywinski, Alberto Lutman, Timothy Maxwell, Michael Sullivan

SLAC National Accelerator Laboratory, Menlo Park, CA, USA

ABSTRACT

We discuss how by using the wake fields generating in a corrugating plate we may increase the resolution of a transverse diagnostic cavity while producing an extremely short X-ray pulse at LCLS.

Attosecond measurement in LTU

Thanks to Rick Iverson

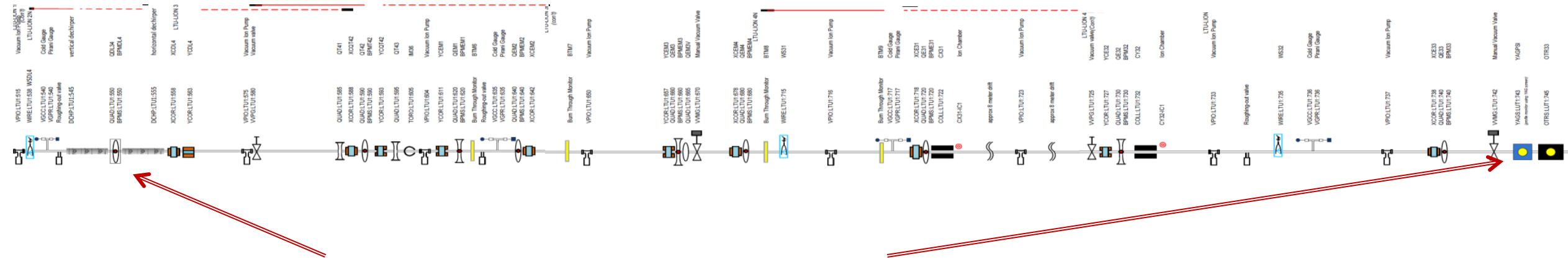

Kick the beam horizontally or vertically by the wake fields exciting by the same beam moving near corrugated plates

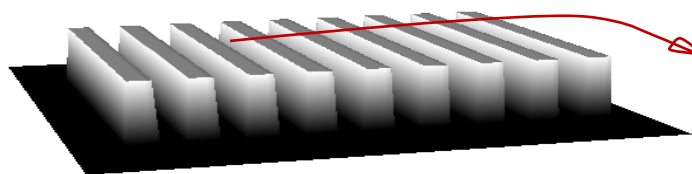

Watch a transverse image on the screen

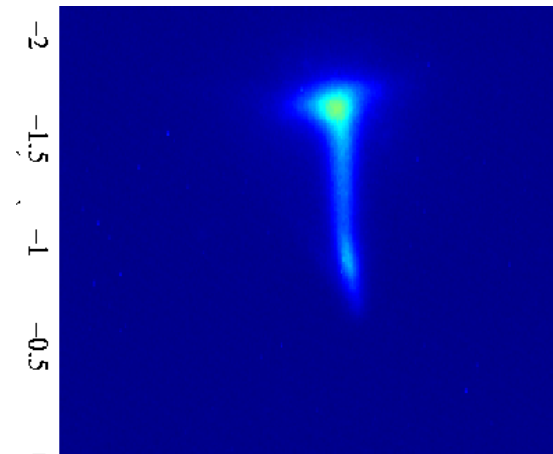

Reconstruct bunch temporal profile

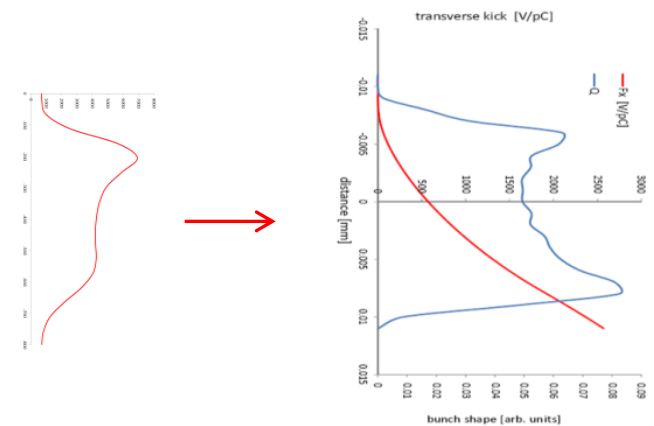

Application for users. Very short X-ray pulses.

DCHP:LTU1:545
 QUAD:LTU1:550
 BPMS:LTU1:550
 DCHP:LTU1:555
 XCOR:LTU1:558

X-corrector is immediately after the horizontal dechirper

Slide of July 2016

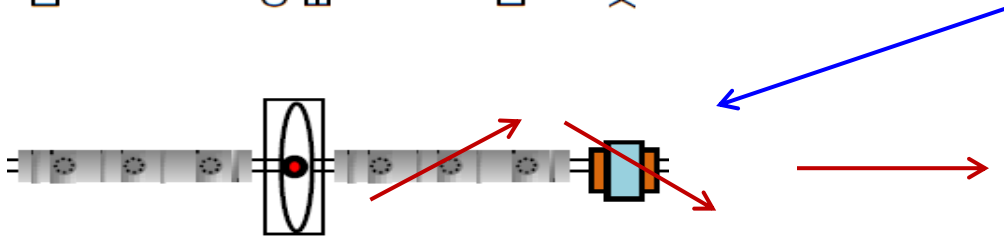

This will give a large kick to the "head"

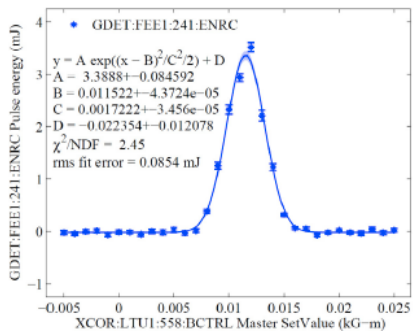

Bunch "tail"

An opposite kick by a corrector to compensate wake kick acting on the "tail" of the bunch

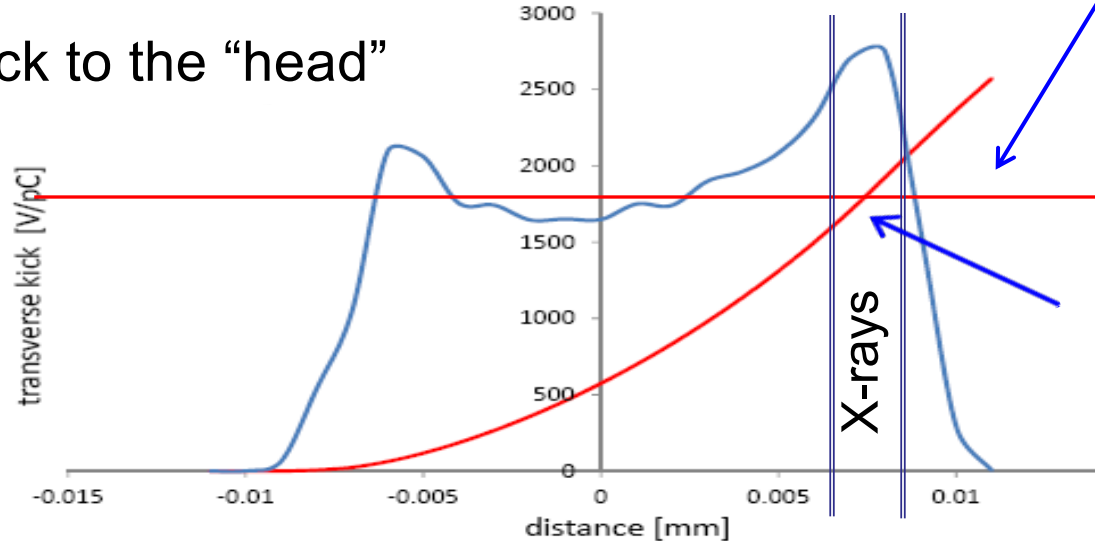

A tail of a bunch will get a perfect, almost linear kick like from XTCAV

X-ray production vs X-corrector

Only "tail" will produce short X-ray pulse

First experimental result

X-ray spectrum changes with a jaw position

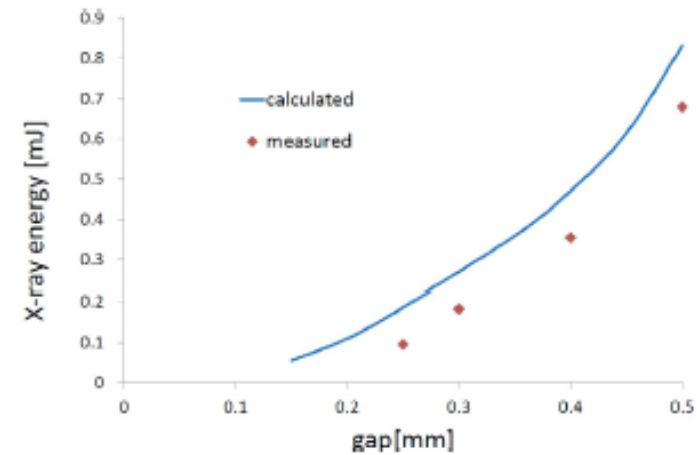
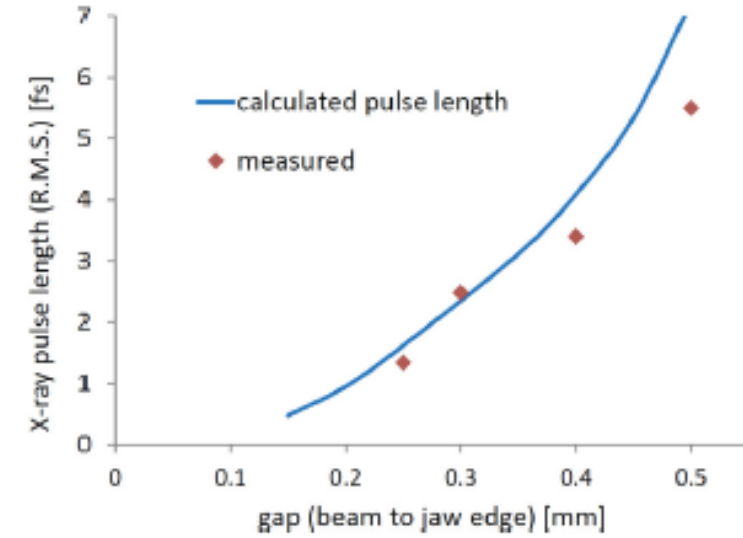
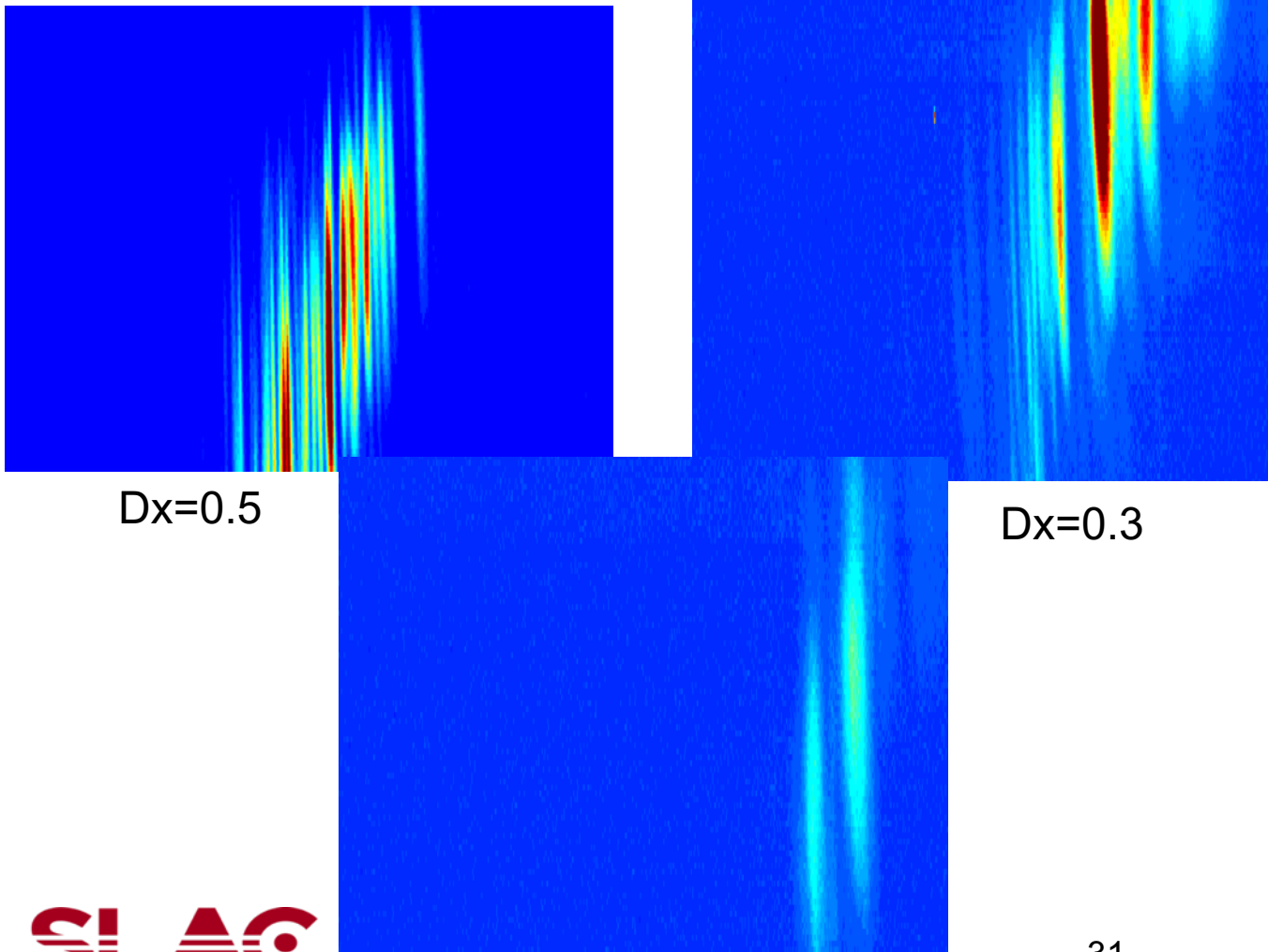

The choice of the IR beam pipe for FCC

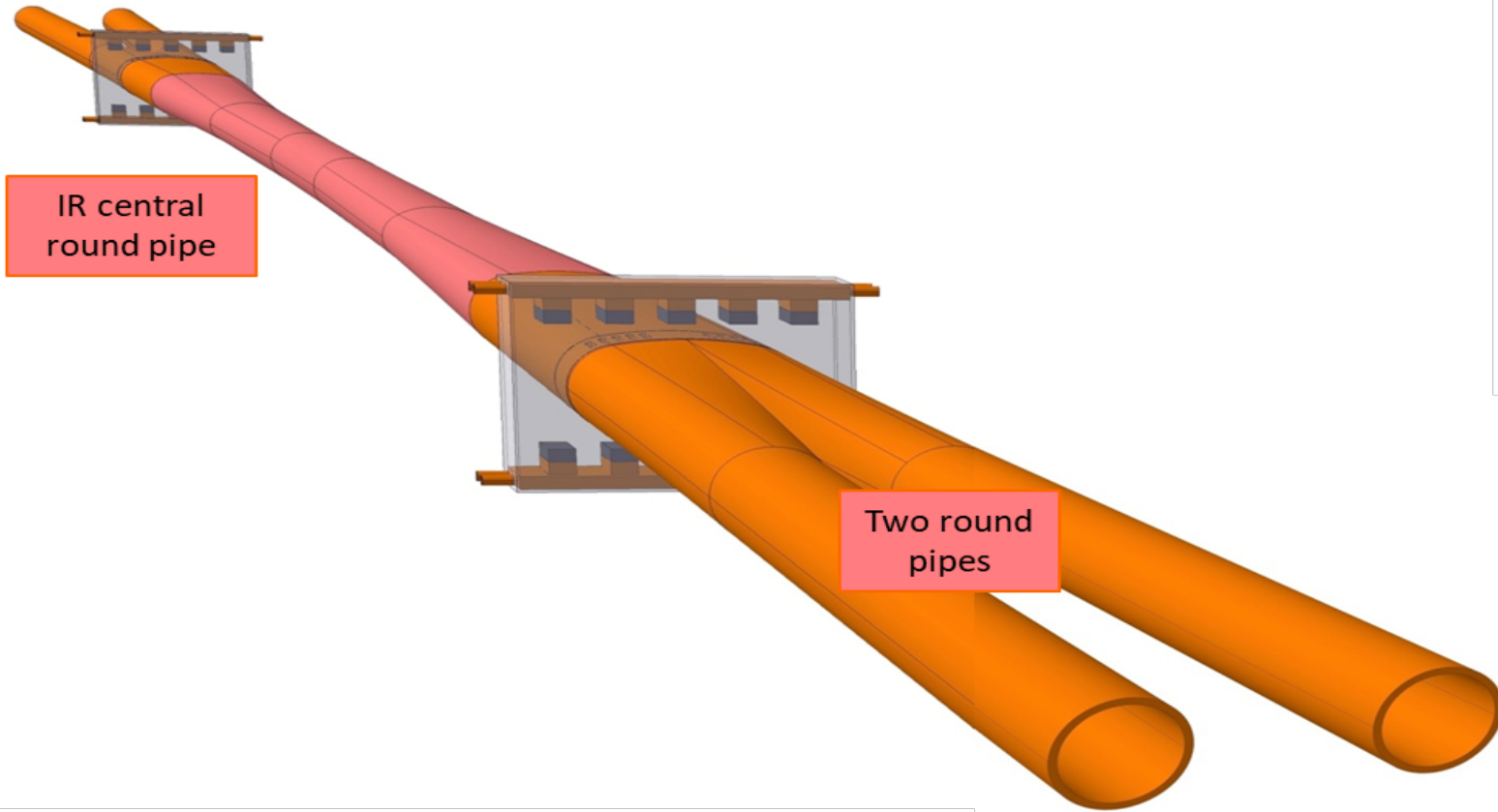

In the design we tried to achieve the minimum of the electromagnetic interaction of the colliding beams with metal walls of the IR beam pipe.

We developed a special smooth transition from two beam pipes to a common central pipe.

The concept of a low impedance IR beam pipe

Smooth transitions at the pipe connections

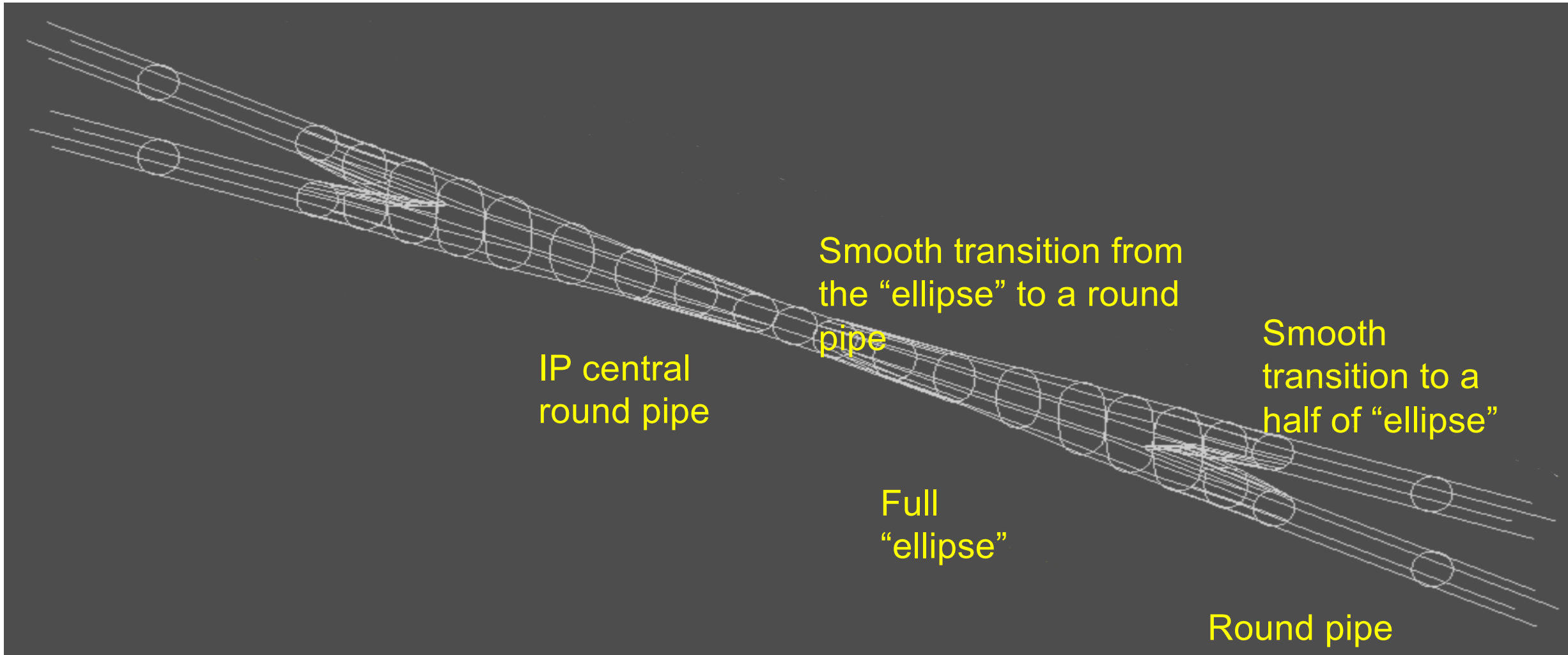

An unavoidable trapped mode in the FCC IR

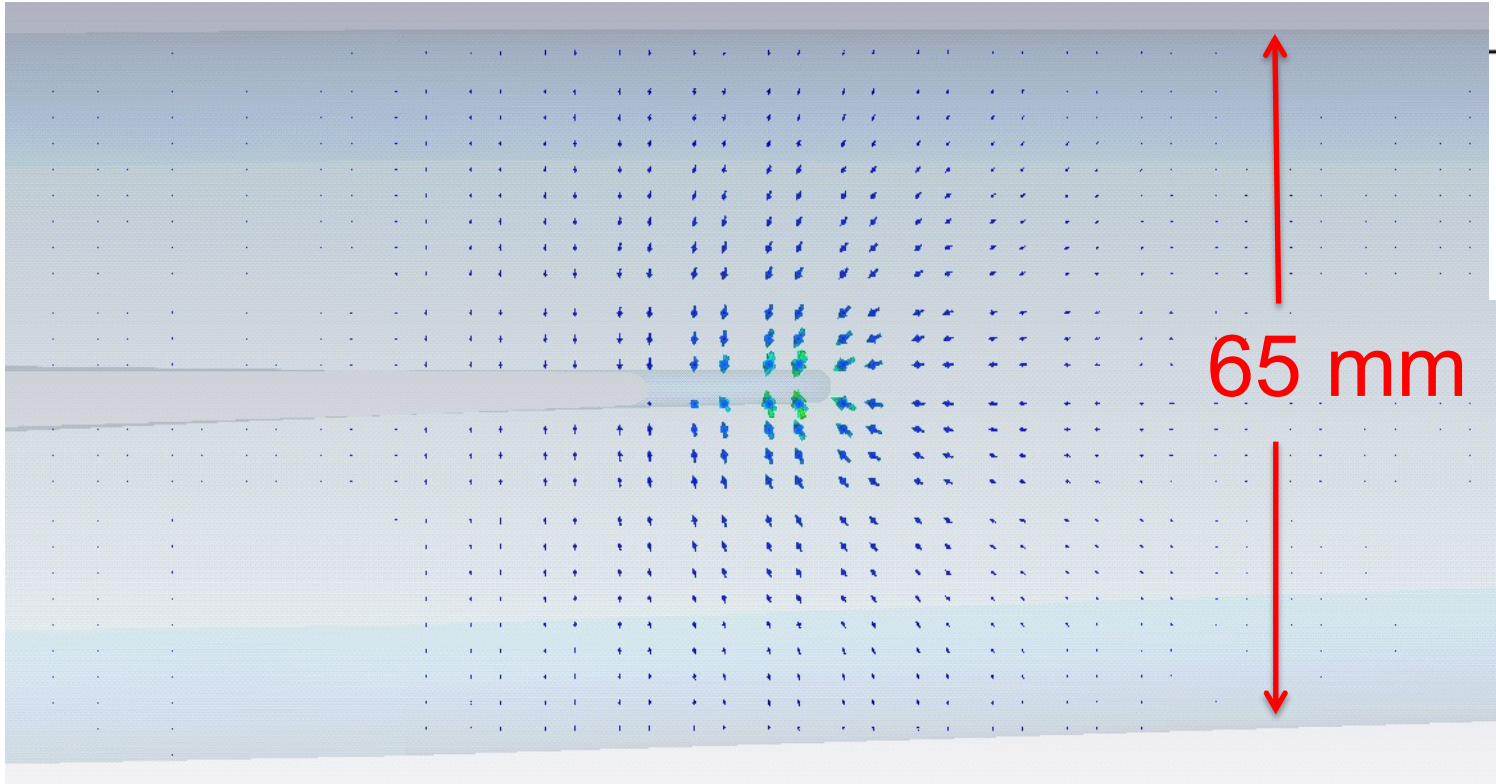

PHYSICAL REVIEW ACCELERATORS AND BEAMS 20, 111005 (2017)

Unavoidable trapped mode in the interaction region of colliding beams

Alexander Novokhatski* and Michael Sullivan
SLAC National Accelerator Laboratory, Menlo Park, California 94025, USA

Eleonora Belli, Miguel Gil Costa, and Roberto Kersevan
CERN, 1211 Geneva 23, Switzerland

A trapped mode is localized in the region where two beam pipes emerge into one. This mode has a transverse electrical component near the pipe connection. If we can make longitudinal cuts in the walls at this region then the trapped mode field will radiate out of the beam pipe.

The concept of the HOM absorber

Based on the property of the trapped mode we have designed a special HOM absorber.

The absorber vacuum box is placed around the beam pipe connection. Inside the box we have ceramic absorbing tiles and copper corrugated plates .

The beam pipe in this place have longitudinal slots, which connect the beam pipe and the absorber box. Outside the box we have stainless steel water-cooling tubes, braised to the copper plates.

The HOM fields, which are generating by the beam in the Interaction Region pass through the longitudinal slots into the absorber box.

Inside the absorber box these fields are absorbed by ceramic tiles, because they have high value of the loss tangent.

The heat from ceramic tiles is transported through the copper plates to water cooling tubes.

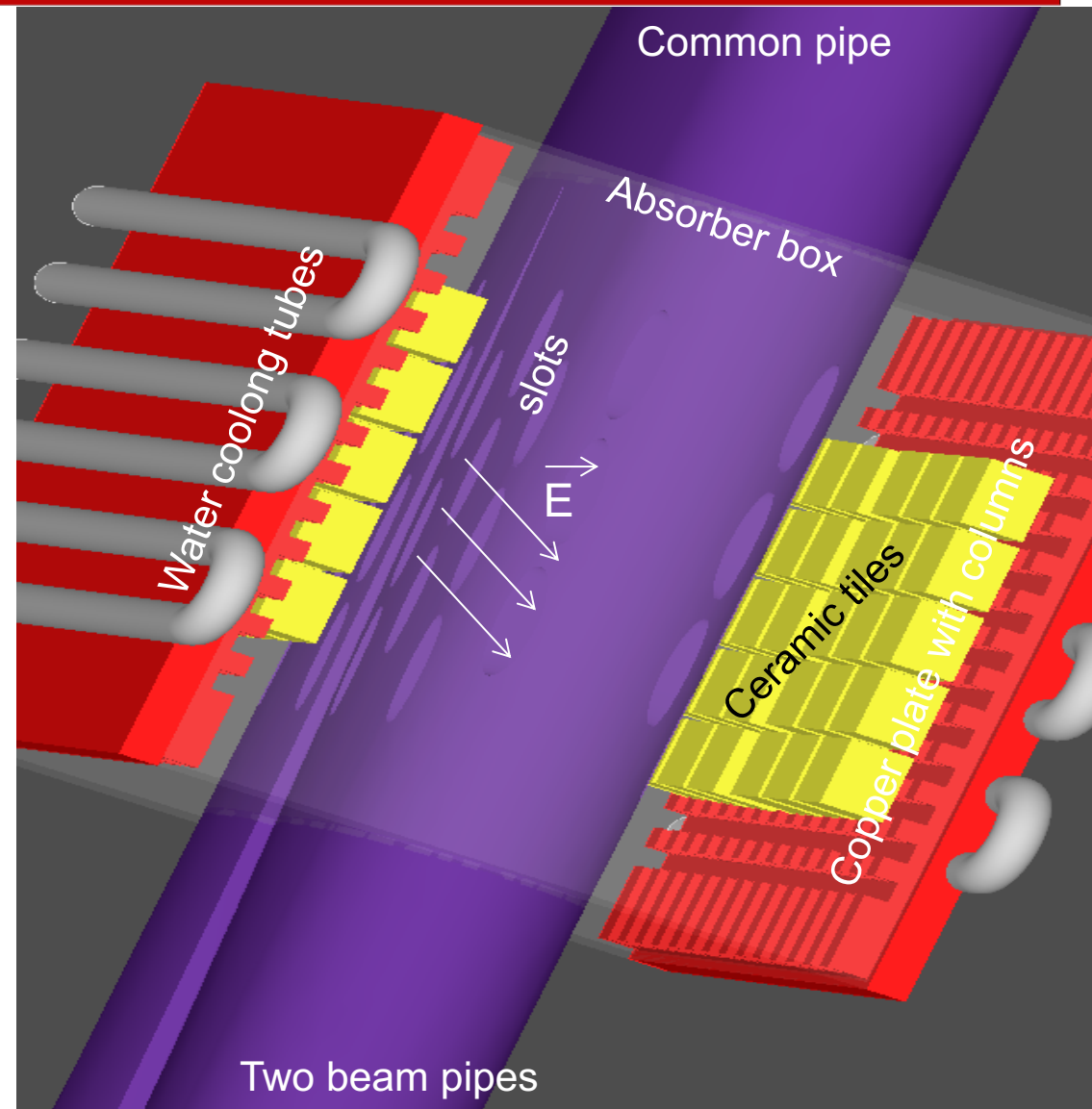

To demonstrate how HOM absorber works we show two cases when ceramic tiles do not absorb the HOM power (loss tangent is zero) and absorb the HOM power.

HOM mode in the IR region when ceramic tiles have vacuum parameters :

$$\varepsilon=1, \delta=0$$

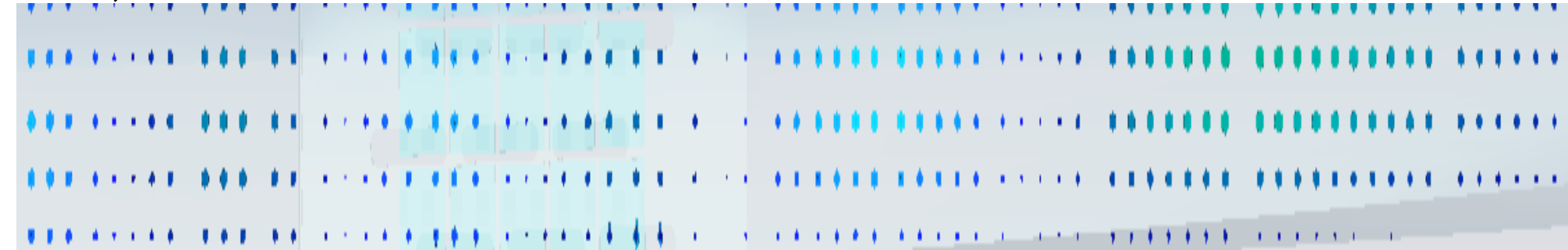

Field is in the beam pipe

HOM mode in the IR region when ceramic tiles have real parameters : $\varepsilon=22,$

$$\delta=0.1$$



Field is concentrated in the absorber region and in the ceramic tiles

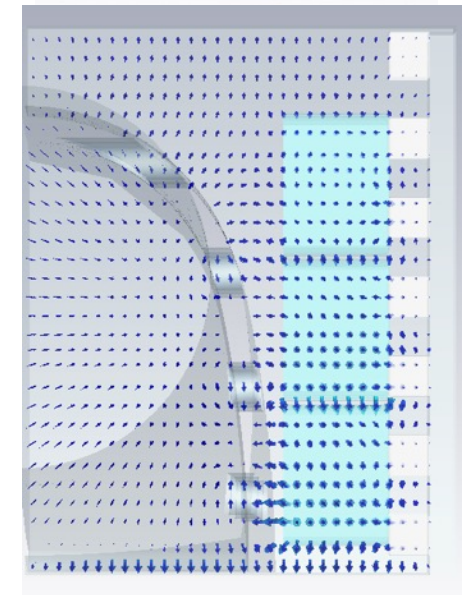
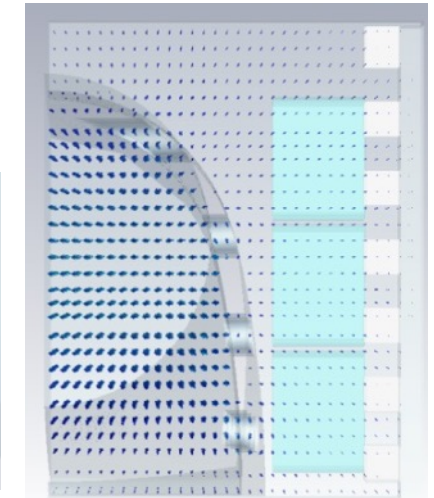

A new geometry with a smaller central Be pipe of 20mm in a diameter

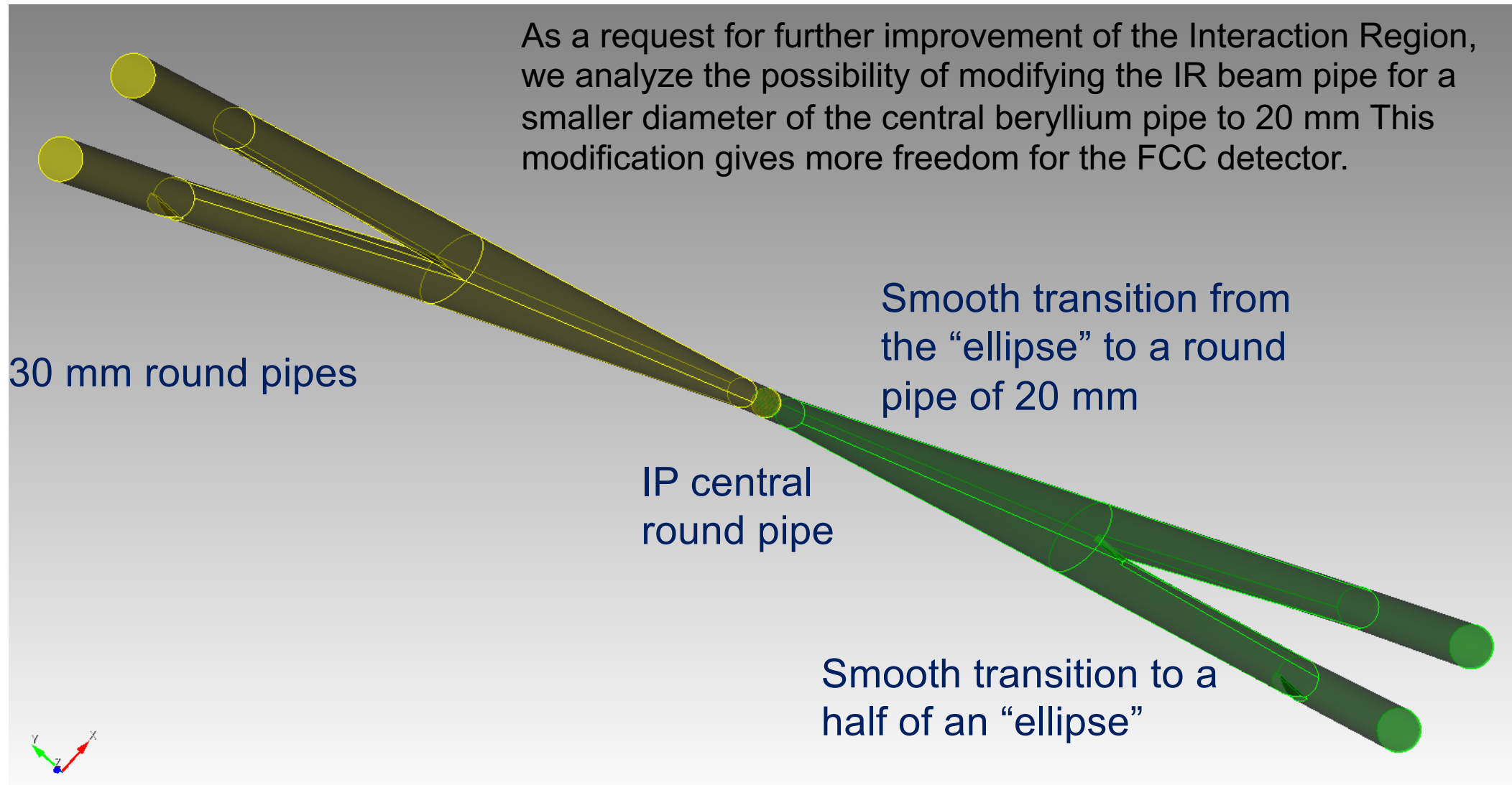

Synchrotron radiation masks

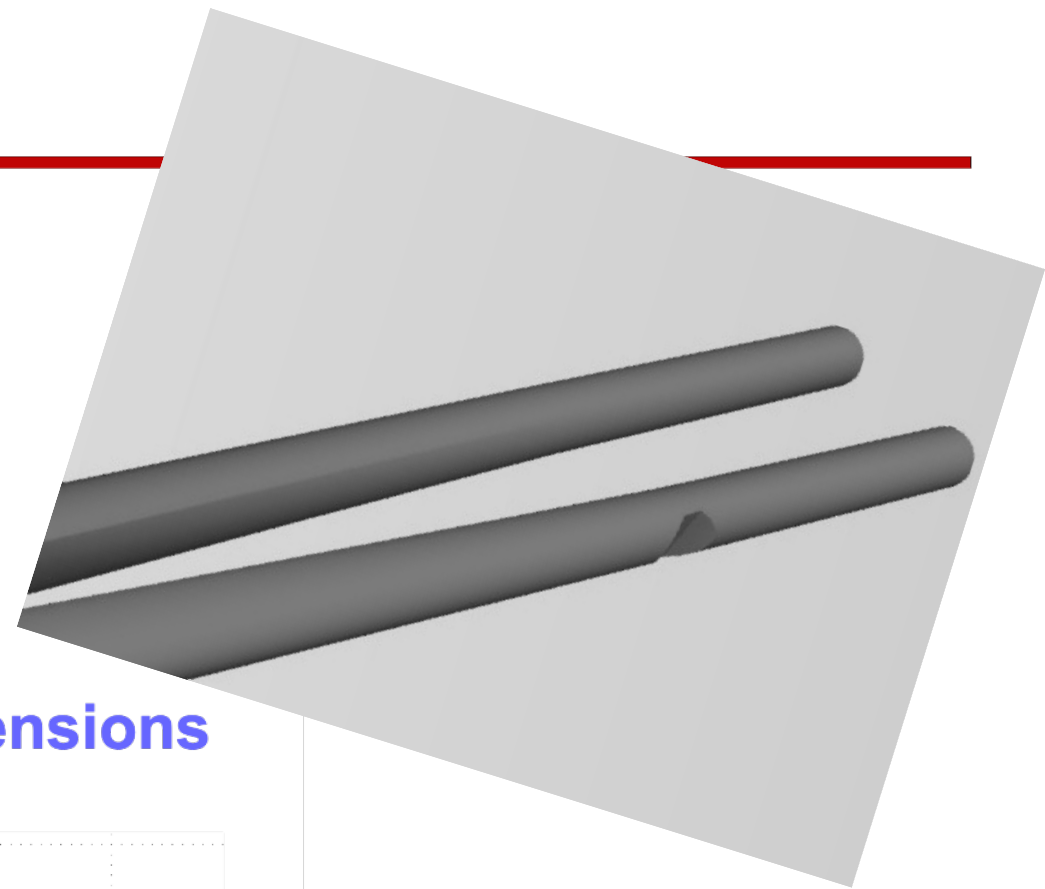
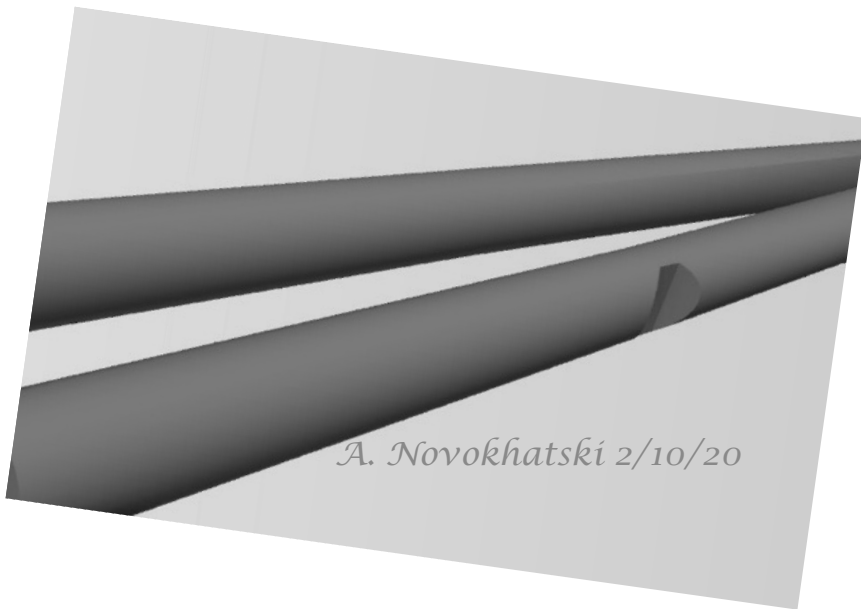

2.1 m mask dimensions

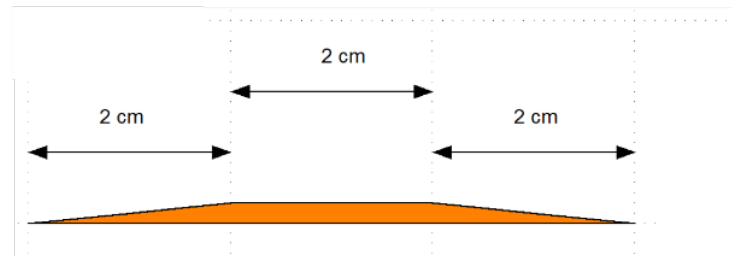

From Mike Sullivan

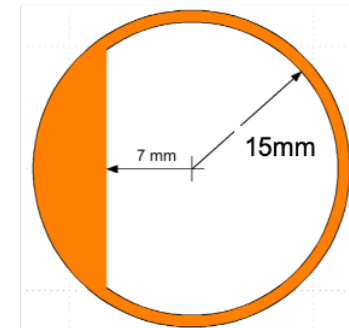

Wake field and frequency spectrum of a new FCC IR

cut-off frequencies

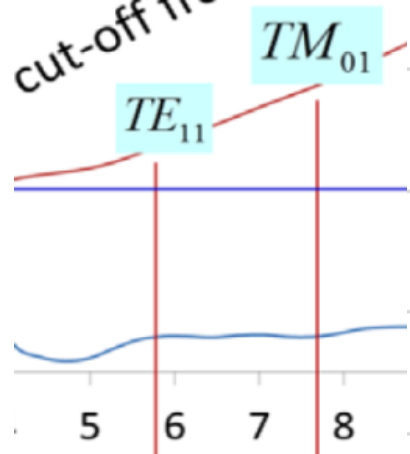

f1=	6.144261	GHz
f2=	6.32322	GHz
f3=	6.442526	GHz

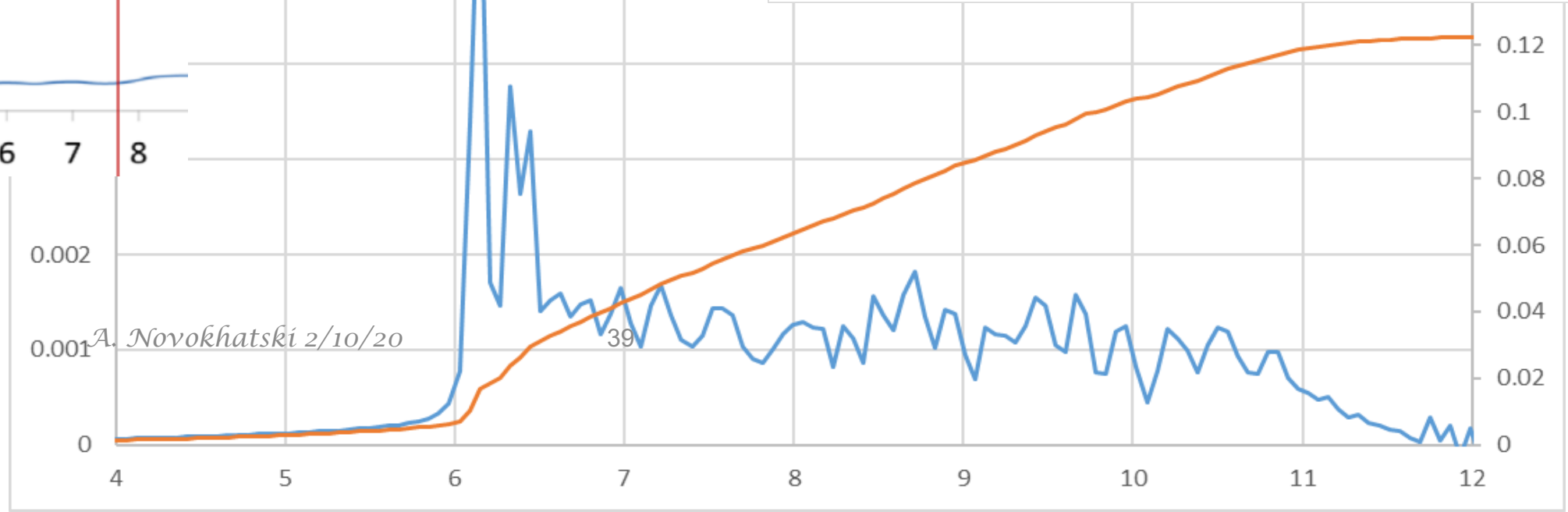
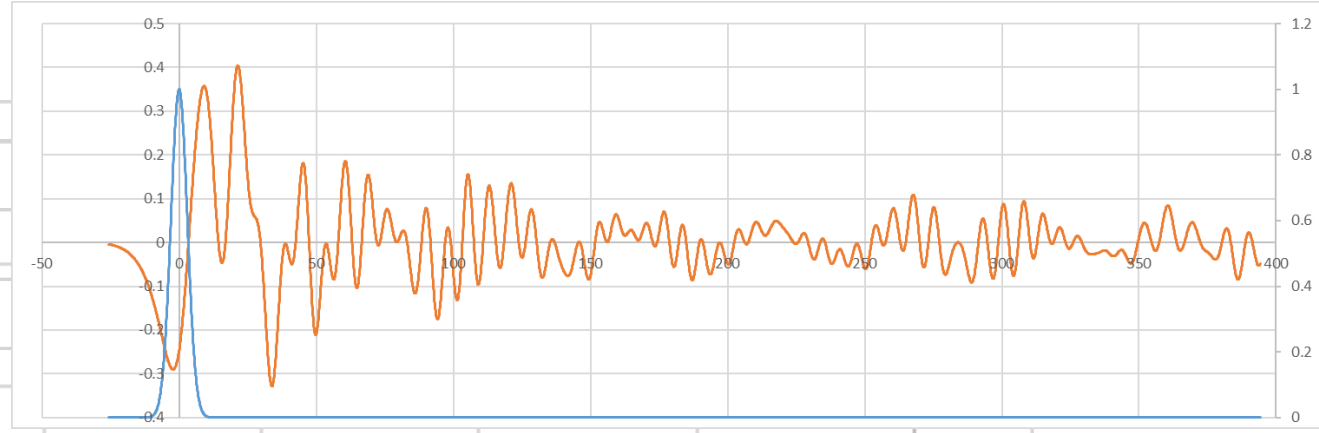

Main trapped mode (there are can be several modes)

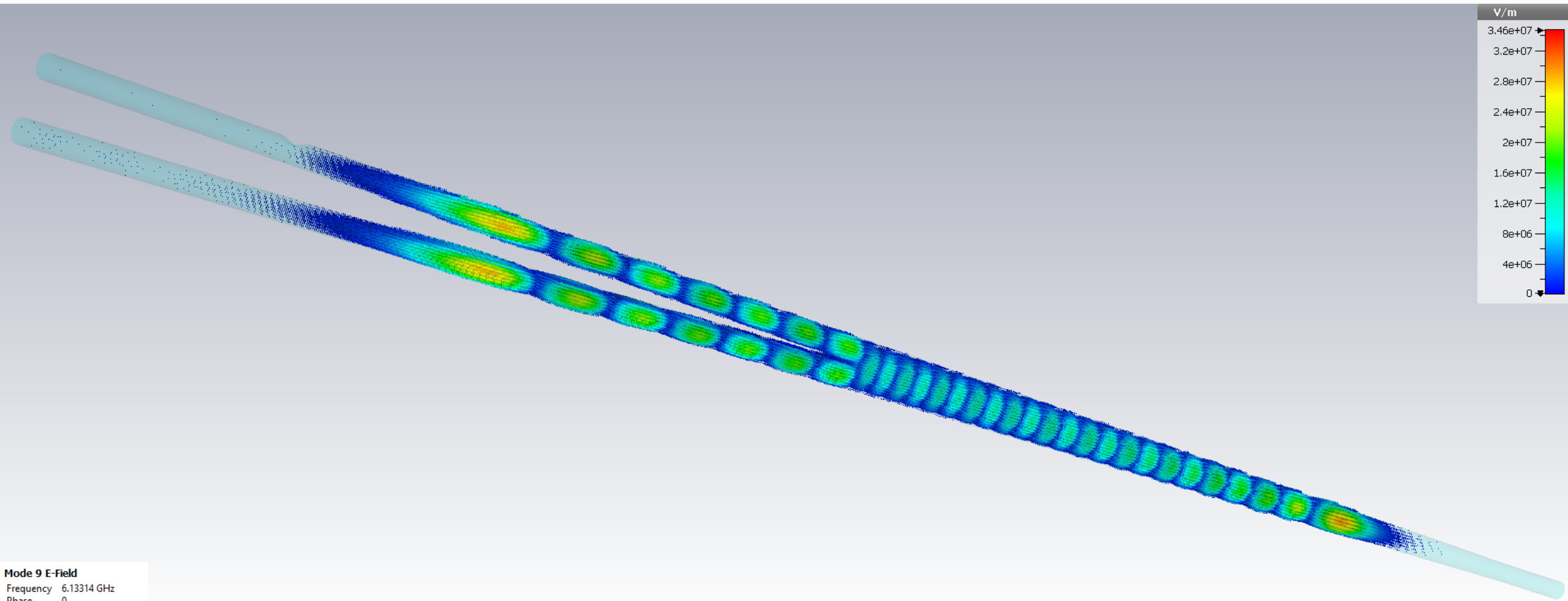

A mode trapped between a central small pipe and a SR mask

Unavoidable modes

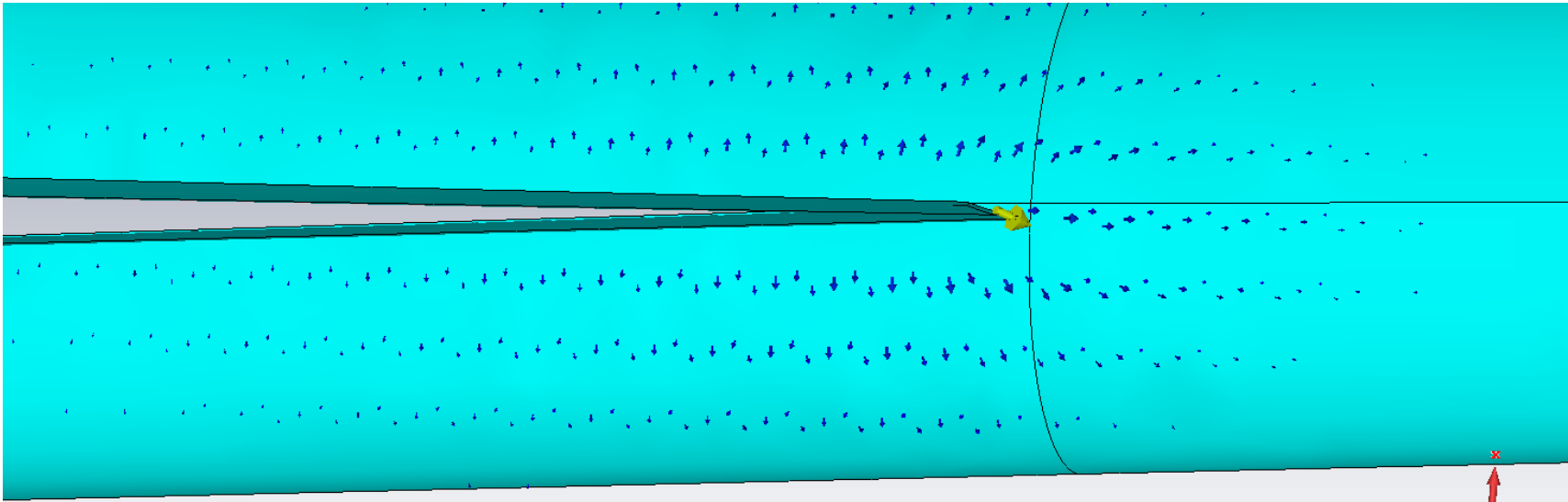

Mode 10 E-Field
Frequency 6.43428 GHz
Phase 45
Maximum 1.13809e+09 V/m

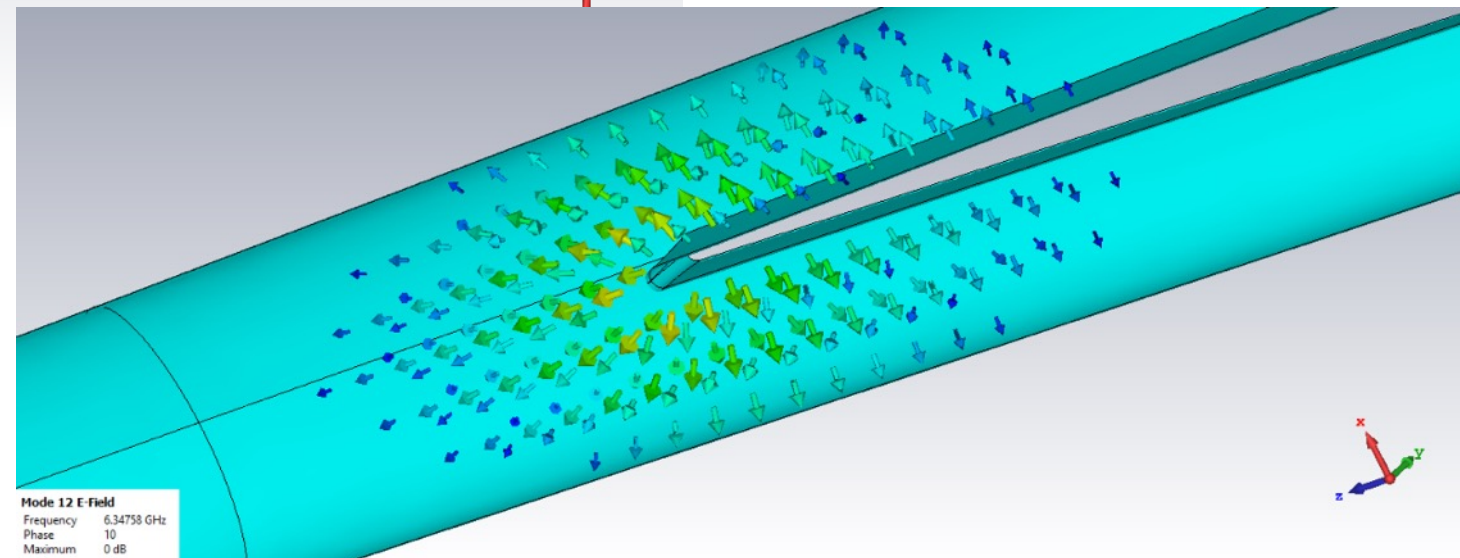

Mode 12 E-Field
Frequency 6.34758 GHz
Phase 10
Maximum 0 dB

It needs more analysis to investigate whether to use or not to use HOM absorber

31.570.61 Novokhatski 27.07.20

41

41

FCC-ee beam parameters

parameter	Z	W	H (ZH)	ttbar
beam energy [GeV]	45.6	80	120	182.5
horizontal emittance [nm]	0.27	0.28	0.63	1.45
vertical emittance [pm]	1.0	1.0	1.3	2.7
longitudinal damping time [ms]	414	77	23	6.6
SR energy loss / turn [GeV]	0.036	0.34	1.72	9.21
total RF voltage [GV]	0.10	0.44	2.0	10.93
energy acceptance [%]	1.3	1.3	1.5	2.5
energy spread (SR / BS) [%]	0.038 / 0.132	0.066 / 0.153	0.099 / 0.151	0.15 / 0.20
bunch length (SR / BS) [mm]	3.5 / 12.1	3.3 / 7.65	3.15 / 4.9	2.5 / 3.3
bunch intensity [10^{11}]	1.7	1.5	1.5	2.8
no. of bunches /beam	16640	2000	393	39
beam current [mA]	1390	147	29	5.4
Averaged bunch spacing [ns]	19.5			
luminosity [10^{34} cm ⁻² s ⁻¹]	>200	>30	>7	>1.3
luminosity lifetime [min]	70	50	42	44

A. Novokhatski 5/31/17 ⁴²

Heat load vs bunch length for central beam pipe of 30 mm, 20 mm and 10 mm

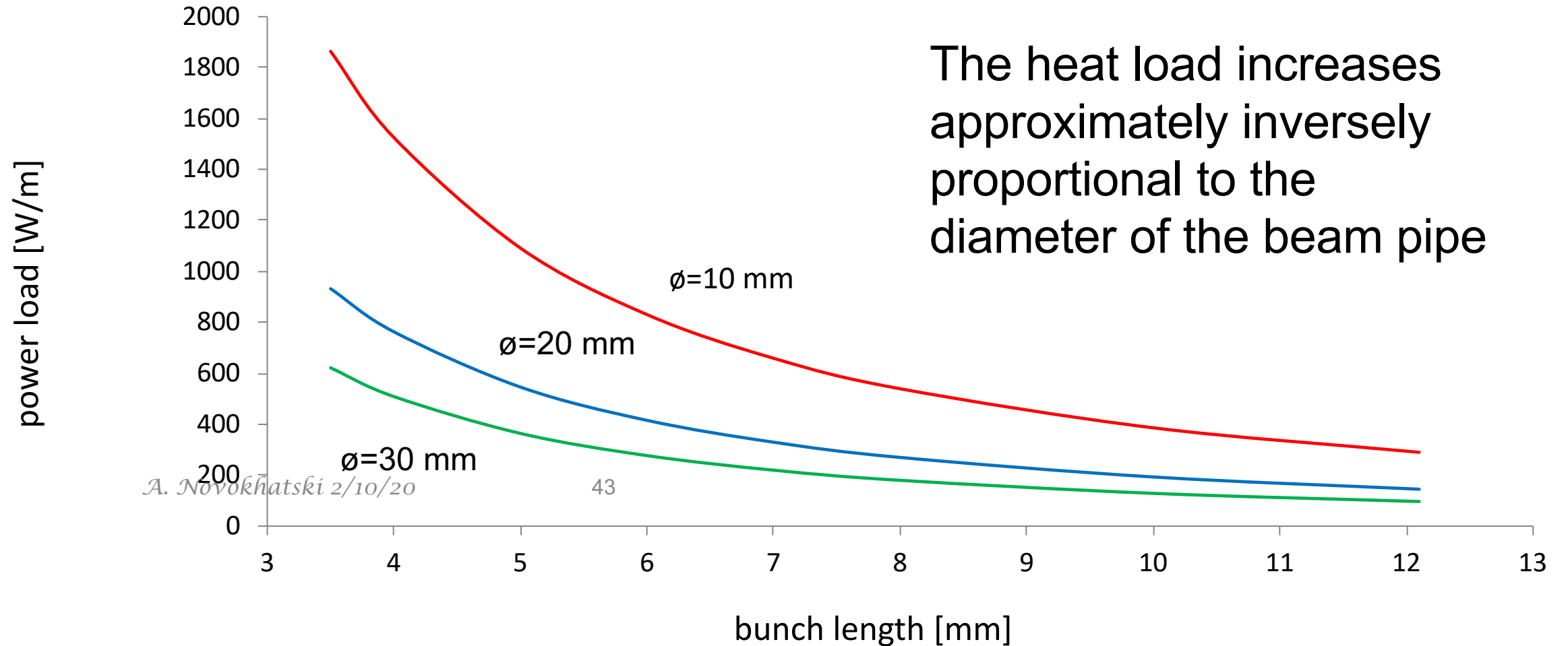

The heat load increases approximately inversely proportional to the diameter of the beam pipe

A. Novokhatski 2/10/20

43

eRHIC IR beam chamber with round pipes in the final focus quads

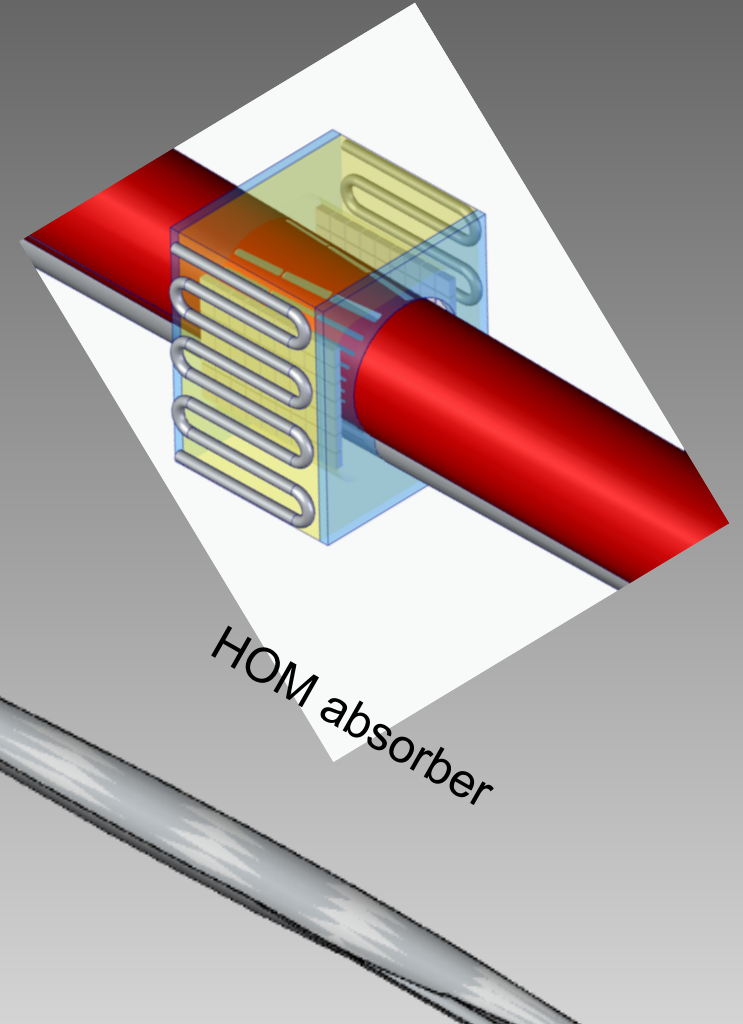
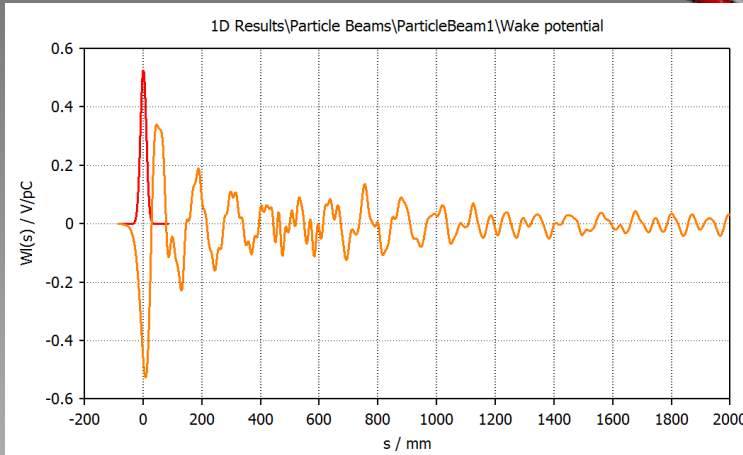

Synchrotron mask

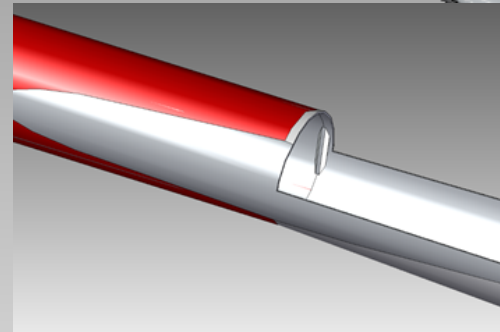

The wake field almost follows the shape of a bunch. That corresponds to creation of the additional bunch self electromagnetic field in the pipe of a larger size.

S. Novokhatski 11/15/19

Conclusions

- Electromagnetic interaction of the beam with the accelerator environment become more and more important with the progress of the accelerator technology.
- Very careful analyses of this interaction is needed for new accelerator projects and upgrade of the operating machines.
- I'm very glad to be involved in this very interesting activity.

Thanks